

World War II The Complete Game



What if.....

You were in charge of the Japanese fleet at Midway?

You were the commanding officer of the Luftwaffe?

You were in charge of the American 3rd Army?

You were a French infantryman defending the Maginot line?

Now is your chance!

You get to determine the fate of history.....

Introduction

In 1997, I began a quest to create what I felt was the ultimate World War II board game. I was working as a computer installer and trainer traveling all over the country and to some other countries as well. I had been to gaming conventions and played many different World War games with people from all walks of life. In 2004, I finished what I felt was this game. Version 11.0 of World War II - The complete game. It had every aspect I wanted in the game and was based on all the information and research I could get my hands on. I had to mold the pieces myself, and pour the pieces by hand then painting them.

Enter 2024. Twenty years of expansion of the internet, as well as the introduction of highly advanced 3-d printing have made my old game not only obsolete, but showed me errors in my map I couldn't believe. I felt an upgrade was in order. So, in June of 2024, I started over from scratch. I have redrawn the version 12.0 map based on several hours of research and pulling up world maps from 1939 from many different sources. By comparing these sources against each other to get a consensus of borders, political control, troop strengths, and production capabilities, I feel I now have a much more accurate depiction of the world and its state at the time.

Again, I would like to pay tribute to the men and women of the armed forces around the world who fought in this devastating war. It is their dedication and sacrifice that has allowed me the freedom to create this game, and I dedicate it to their honor. As a former United States Marine, I understand their dedication to God, country, and their fellow man.

There are so many people who have helped me on this project over the years. I have listed as many as I could remember of them in the back. A special thanks to Larry Harris for starting this idea in the first place, and getting us to all play board games again.

Sincerely;

Charles E. Fontaine Jr.

Table of Contents

Section 1.0 - Game Setup.

Team setup by number of players and order of play.	1-1
Setting up the pieces.	1-2
Starting Industrial Production Units (I.P.U's) and how they work	1-3
The Map Board.	1-4
History and specific rules for playing each individual country.	
Italy.	1-5
Germany.	1-6
France.	1-7
United Kingdom.	1-8
Japan.	1-9
United States (USA).	1-10
China.	1-11
U.S.S.R (Russia).	1-12
Neutral Countries / Minor Powers .	1-13

Section 2.0 - Detailed description of the game units.

Land units	
Regular Infantry units.	2-1
Special Forces Infantry units.	2-2
Reserve Infantry Units.	2-3
Armored Personal Carriers (APC's).	2-4
Armor Units (Tanks).	2-5
Air Units	
Fighter Units.	2-6
Transport Plane Units.	2-7
Bomber Units.	2-8
Sea Units	
Transport Ship.	2-9
Submarines.	2-10
Destroyers.	2-11
Cruisers.	2-12
Aircraft Carriers.	2-13
Battleships.	2-14
Miscellaneous Units	
Anti Aircraft / Anti Armor Gun.	2-15
Coastal Gun.	2-16
Rocket Launcher.	2-17
Radar Unit.	2-18
Spy Unit.	2-19
Atomic Bomb Unit.	2-21
Industrial Factory Units.	2-23
Country Markers	2-24

Table of Contents

Section 3.0 - Detailed description of each player's turn.

3.1 - Declare war.	3-1
3.2 - Develop Technology.	3-3
3.3 - Repair damage from Economic Bombing raids (EBR).	3-4
3.4 - Purchase new units.	3-5
3.5 - Combat movement.	3-6
3.6 - Combat	3-7
3.7 - Non-Combat movement.	3-11
3.8 - Repair of multiple hit Units.	3-12
3.9 - Industrial Factory takeover and surrender of IPU's	3-12
3.10 - Capital Factory takeover of a country.	3-13
3.11 - Placement of purchased Units.	3-17
3.12 - Collect IPU income and end turn.	3-17

Section 4.0 - Victory Conditions.

4.1 - Team victory conditions.	4-1
4.2 - Individual country victory conditions within a team.	4-1

Section 5.0 - Appendices and Charts.

Appendix A - Game unit setup charts.	5-1
Appendix B - Technology Chart.	5-20
Appendix C - Economic Bombing Raid (EBR) rules and chart.	5-21
Appendix D - Sea Search rules and chart.	5-23
Appendix E - Aircraft Carrier readiness rules and chart.	5-24
Appendix F - Diplomacy rules and chart.	5-25
Appendix G - Player reference card.	5-26
Appendix H - Battle reference card.	5-27
Appendix I - Alternate Game rules for Empire building edition.	5-28
Appendix J - IPU Template	5-29
Appendix K - Recommended minimum pieces to make and purchase	5-30
Acknowledgments and thanks.	5-31

Section 1.0 - Game Setup

Team setup by number of players and order of play

This section of the rules will explain how to setup the board to play the game. As this is not your simple everyday game, setup time is approximately 1 hour, as there are several hundred pieces on the board at the beginning of the game.

World War II - The Complete game (WWII TCG) is a 3-8 player game. Here is the breakdown for each team depending on how many players are involved.

3-player game:

Player 1: Italy, Germany, Japan.
Player 2: France, United Kingdom, China, USA.
Player 3: Russia.

4-player game:

Player 1: Italy, Germany, Japan.
Player 2: France, United Kingdom.
Player 3: China, USA.
Player 4: Russia.

5-player game:

Player 1: Italy, Germany.
Player 2: France, United Kingdom.
Player 3: Japan.
Player 4: China, USA.
Player 5: Russia.

6-player game:

Player 1: Italy, Germany.
Player 2: France.
Player 3: United Kingdom
Player 4: Japan.
Player 5: China, USA.
Player 6: Russia.

7-player game:

Player 1: Italy.
Player 2: Germany.
Player 3: France.
Player 4: United Kingdom.
Player 5: Japan.
Player 6: China, USA.
Player 7: Russia.

8-player game:

Player 1: Italy.
Player 2: Germany.
Player 3: France.
Player 4: United Kingdom
Player 5: Japan
Player 6: China.
Player 7: USA.
Player 8: Russia.

No matter how many players you have, The order of players turns is always:

Player 1: Italy.
Player 2: Germany.
Player 3: France.
Player 4: United Kingdom
Player 5: Japan.
Player 6: China
Player 7: USA.
Player 8: Russia.

Setting up the Pieces on the board.

WWIITCG uses plastic playing pieces to represent each of the units on the board. It also deploys plastic chips in various colors to indicate multiple units of each type within a land or sea zone. These pieces and chips depict groups of that particular type of unit in various numbers. Where an Infantry unit might depict 10,000 men, a battleship piece would only depict 2-3 ships. The setup of the game reflects a very close representation of where the actual troop strength were at the beginning of WWII, taking into condition many different factors. Among these are relative strength between similar units for different countries, balance for game play to give each side an equal chance to win, and unit training levels based on historical information.

Each country uses a specific color of units. They are;

Italy.....	Purple.
Germany.....	Silver.
France.....	Blue
United Kingdom.....	Bronze
Japan.....	Yellow
USA.....	Green
China.....	Turquoise
Russia.....	Red
Neutral Countries / Minor powers.....	Peach

APPENDIX A. Starting layouts contains detailed information for every zone on the map. The neutral countries / Minor Powers land units do not need to be setup as they come into play only when a player tries to take over one of these zone either through force or diplomacy.

Chips are used an provided with the game to represent multiple units within a zone. The value of these chips is as follows;

White Chips.....	1 unit
Red Chips.....	5 units
Blue Chips.....	10 units
Yellow Chips.....	20 units

The unit piece on top of a stack of chips also represents 1 of those units. Chips are used to only represent additional units of that type. For example, a stack of 3 white chips with an armor unit on top of it would represent a total of 4 armor units. A stack containing 1 red chip, 2 white chips, and a regular infantry unit on top would represent a total of 8 regular infantry units.

Each players units are broken down into 2 charts: 1 for land zones on the map, and 1 for sea zones on the map. Each player needs to setup all of their pieces based on both charts.

One other color of chips are provided with the game for special purposes. These chips do not represent the presence of a unit, but a unit type or condition a particular unit.

Black Chips..... Indicates a unit has been damaged. (1 black chip per damage point).

Starting Industrial Production Units (IPU's) and how they work.

Industrial Production Units or IPU's are the life blood to the game. On each turn, players spend their IPU's to purchase units, technology, and economy. The number of IPU's a player collects this turn to spend on next turn is based on the land zones they possess. An IPU basically represents a certain number of man hours of production and raw materials to complete the production. Each player starts the game with a specific amount of IPU's on game turn 1. This amount may be greater or less than what they will collect at the end of game turn 1. The starting amount for each player at the beginning of the game is based on that country's preparedness to enter the war should it occur. A countries' economy may rise or fall in different ways. If a country conquers a new land zone that has a set IPU value, (the white circle on a zone with a number inside of it), then that countries' economy is raised by that amount. A country may also invest in the economy of a land zone that has an Industrial factory unit on it. The player pays 5 IPU's and places a white chip under the factory unit. The effect increases the value of the land zone by 1 IPU for the remainder of the game. These chips under a factory unit are called Economic Upgrade Chips. (Limitations for building these chips are explained later).

Starting amount of IPU's for each country.

Italy	10 IPU's
Germany	32 IPU's
France	25 IPU's
United Kingdom	46 IPU's
Japan	30 IPU's
China	26 IPU's
USA	30 IPU's
Russia	26 IPU's

Starting Economy for each Country at the beginning of the game.

Italy	13 IPU's
Germany	28 IPU's + up to 15 N.S.
France	30 IPU's
United Kingdom	59 IPU's
Japan	37 IPU's
China	28 IPU's
USA	35 IPU's + 5 Occupied
Russia	42 IPU's

The Map Board.

The main Map board is 70 Inches by 118 inches and depicts the entire world both geographically and politically as it was on August 31, 1939. It is divided up into 3 main sections. 1) The main central map. 2) The 134 blow up boxes showing a better detail of the smaller regions of the world. 3) There are 2 sections of the world that players may not enter with any of their pieces. They are Switzerland and the orange sea zone at the bottom center where the name of the game is depicted.

The map may be crossed over via travel east and west from the left of the map to the right and vice versa. Players may not cross over from north to south as these 2 side do not touch each other.

Please note that all land and sea zones are separate from each other. All Islands in a named group are considered to be the same land zone (i.e. The Hawaiian Islands are 1 land zone.)

Any Land or sea zone on the map that has no designated name (i.e. most of the islands in the Alaskan Aleutian islands chain) are not part of the game. They are depicted on the map for looks only. Land and air units cannot land in them. The Caspian and Black sea zones are actual zones on the map, where as the great lakes in the USA are not.



Historical Background and Special Rules for each Country.

ITALY.

CAPITOL: ITALY
GOVERNMENT: MONARCHIAL FASCISM
RULER: BENITO MUSSOLINI



Italy at this point in history is in a true point of indecision. They have been alienated by France and England for their conquests in Africa, left the league of nations, and signed the "Pact of Steel" with Germany. But Mussolini feels like Hitler's "puppet" because his troop numbers, efficiency and technology no where near match those of Germany. Meanwhile, at home in Italy, he is trying to keep the favor of the Pope, by allowing crosses back in school, while trying to still teach fascism.

So now Italy is being thrown into a war it is not ready for. During the game, Italy and Germany take their turns at the same time. They fight together in combat, and when they conquer a new territory, whoever has the most attack points left in the zone, gets economic control of that zone. The only exception to this is when an original German or Italian territory is liberated from the allied forces. On those occasions, the original owner receives control of their territory again.

Special Rules for the Italians:

1. German and Italian units may occupy the same land and sea zones at the same time.
2. Italy never declares war on another player. Its war and allies policies are dictated strictly by the political acts of Germany.
3. Italy cannot lend lease its economy to anyone. It may receive up to 5 IPU's **maximum** in lend lease from either Germany or Japan in one game round.
4. Italy purchases Armor (Tanks) units at a cost of 4 IPU's instead of 5.
5. Italian special forces use a combined arms special ability that when a Regular Infantry Unit, an Armor (Tank) unit, and a Special Forces Unit attack as a group, the Special Forces unit attacks on a die roll of 3 instead of 2.
6. Italy cannot relocate its Capitol Factory. If the capitol province falls, all of Italy's units and remaining provinces are converted to Germany and German units. Italy is then eliminated from the game.

7. On the **2nd game round only**, Italy may purchase the following units at a special cost:

Albania	1 Regular Infantry unit	1 IPU
Italy/Sardinia Sea Zone	1 Aircraft Carrier	10 IPU's
Italy/Sardinia Sea Zone	2 Destroyers	5 IPU's each
Italy	2 Armor (Tanks) units	3 IPU's each

Historical Background and Special Rules for each Country.

GERMANY

CAPITOL: BERLIN
GOVERNMENT: DEMOCRATIC SOCIALISM
RULER: ADOLF HITLER



Germany is in a position to expand rapidly. With seven other nations ready to join with her empire, and Italy already on her side, she has the largest army in the world. Her submarine technology is feared by everyone. Over the last 10 years, she has developed the latest weapons, and boasts the most brilliant scientists in the world. Their leader, Adolf Hitler, has brought Germany out of one of the worst depressions known to mankind, and turned them back into a world power to be reckoned with....

Italy and Germany take their turns at the same time. They fight together in combat, and when they conquer a new territory, whoever has the most attack points left in the zone, gets economic control of that zone. The only exception to this is when an original German or Italian territory is liberated from the allied forces. On those occasions, the original owner receives control of their territory again.

Special Rules for the Germans:

1. German and Italian units may occupy the same land and sea zones at the same time.
2. Germany is allowed to relocate its capitol under the rules of capitol factory takeover.
3. Germany may lend up to 5 IPU's to Italy and up to 10 IPU's to Japan per turn. Germany may also lend up to 10 IPU's to Russia per turn if Russia declares war on the Allied regime.
4. Germany purchases Submarine units at a cost of 6 IPU's instead of 8.
5. German special forces use a combined arms special ability that when a Fighter Unit, an Armor (Tank) unit, and a Special Forces Unit attack as a group, the Special Forces unit attacks on a die roll of 3 instead of 2.
6. German submarines use a combined arms special ability called a "Wolfpack". When 3 submarine units attack together as a group, on the FIRST round of combat, each unit attacks on a die roll of 3 instead of 2.
7. There are 7 NAZI sympathizer nations on the board, colored in light grey. If Germany is the first to reach them, and land ANY infantry unit in them during Any-Combat movement phase, then these nations and all their military will join Germany's side in the war. This can be accomplished by standard movement, Parachuting, or being transported by air, land, or sea transportation. THIS MUST BE ACCOMPLISHED IN ROUND ONE OR ROUND TWO OF THE GAME, or the Nazi sympathizer countries convert to standard neutral countries.
8. There is a special border in the game called the Zigfried / Maginot line (red border between Luxemburg / Rhine River Valley / Bavaria / France. If **ANY** units cross this line to attack German Units in the Rhine River Valley or Bavaria, then all German regular infantry and special forces infantry units get to subtract 1 from all their defense die rolls.
9. On the **2nd game round only**, Germany may purchase the following units at a special cost:

Berlin / Sweden Sea Zone	1 Battleship	14 IPU's
Bavaria	4 Regular Infantry units	2 IPU's each
Ruhr Valley/Netherlands Sea Zone	3 Submarines	4 IPU's each
Ruhr Valley	2 Transport Planes	5 IPU's each

Historical Background and Special Rules for each Country.

FRANCE

CAPITOL: FRANCE
GOVERNMENT: PARLIAMENTARY
PREMIER: Édouard Daladier



France is a country in total indecision at this time. It has a decent army, but morale is low, and arrogance is high. The French army leaders don't think they need any help to defend France, but they're not ready to take on the German army, due to its superior weaponry, in an assault. The French army feels that the Maginot line is the best solution against Germany, and prefers to defend. It is also uncertain where Italy's loyalty lies and knows that its defense is weak in that area.

The French underground is well established, and has been aiding people to get out of Germany for years. Underground tunnels exist everywhere, and "safe" houses abound. This is why French Special forces defend original French territories so well.

Special Rules for the French:

1. Until France declares war against the German/Italian regime, England and the USA cannot deploy more than 2 ground and 2 air units on any zone of French soil each.
2. France is not allowed to relocate its capitol under the rules of capitol factory takeover. There is a special special section in the rules for France take over.
3. France may lend lease up to 5 IPU's total per turn to either the United Kingdom or the USA. France may never lend lease to Russia.
4. France purchase Special Forces Infantry at a cost of 3 IPU's instead of 4.
5. French Special forces defend any original French (dark blue) zone on a die roll of 3 instead of 2.
6. There is a special border in the game called the Zigfried / Maginot line (red border between Luxemburg / The Rhine River Valley / Bavaria / France). If **ANY** units cross this line to attack French Units in France, then all French regular infantry and special forces infantry units get to subtract 1 from all their defense die rolls.
7. On the **2nd game round only**, France may purchase the following units at a special cost:

France	2 Regular Infantry Units	2 IPU's each
France	1 Special Forces Infantry Unit	2 IPU's
French West Africa	1 Regular Infantry Unit	2 IPU's
France / England Sea Zone	2 Destroyers	5 IPU's each

Historical Background and Special Rules for each Country.

United Kingdom

CAPITOL: ENGLAND
GOVERNMENT: PARLIAMENTARY.
PRIME MINISTER: NEVILLE CHAMBERLAIN



The United Kingdom is a nation very upset by recent events. Germany has been threatening Poland, France, and other nations. They see no other choice, but to go to war, if Germany doesn't change her ways. Due to the lies and mistrust of Adolf Hitler, England has been building up her military for years. Unfortunately, her Empire is so large, that it is almost impossible to protect all of it. His majesty's government has been trying to talk the USA into joining her in this cause, however, the USA wants no part in "another war in Europe". The USA is willing to lend the U.K. resources to help her, but not men.

Special Rules for the United Kingdom:

1. Until France declares war against the Axis regime, The United Kingdom cannot deploy more than 2 ground and 2 air units on any zone of French soil each.
2. The United Kingdom is allowed to relocate its capitol under the rules of capitol factory takeover.
3. The United Kingdom may lend lease up to 10 IPU's total per turn to either France, the USA, or Russia, if Russia has declared war on the Axis regime and joined the allies..
4. The United Kingdom purchases Transport planes at a cost of 6 IPU's instead of 8.
5. U.K. Special forces attack as a paratrooper from a transport plane on a die roll of 3 instead of 2.
6. The U.K. may purchase units directly from the USA at a cost of -1 IPU's under the following conditions:
 - A. USA Regular infantry units and Special Forces Units are not allowed to be purchased.
 - B. The USA land and air units are on U.K. Soil at the beginning of the U.K's turn.
 - C. The USA sea units are in a sea zone adjacent to U.K. Soil at the beginning of the U.K's turn.
 - D. The USA player agrees to the purchase.
 - E. The USA units are removed from the board during the purchase units phase of the turn, and returned as identical U.K. Units in the same location during the place units phase.
 - F. The USA receives all IPU income for these purchases.
7. The United Kingdom has no special 2nd turn only purchases like other nations.

Historical Background and Special Rules for each Country.

JAPAN

CAPITOL: JAPAN
GOVERNMENT: MONARCHIAL EMPIRE
EMPEROR: HIROHITO



Japan is a country that has been on the rise for almost 15 years. In the mid 20's, Japan entered into trade agreements with several nations (including the USA) to obtain precious commodities like food, steel, and machinery to build their country through the industrial revolution. In the mid 30's, Japan marched into Manchuria and Korea to expand their empire. In the late 30's, Japan found a need for more and more resources to trade, so it starting island hopping throughout the pacific to find new lands. The people of Japan are extremely loyal to their emperor, and would gladly die for him.

Special Rules for the Japanese:

1. Japan is allowed to relocate its capitol under the rules of capitol factory takeover.
2. Japan may lend up to 5 IPU's to Italy and up to 10 IPU's to Germany per turn. Japan may also lend up to 10 IPU's to Russia per turn should Russia declare war on the allied forces.
3. Japan purchases Fighter units at a cost of 8 IPU's instead of 10.
4. Japanese special forces defend any amphibious assault attack on a die roll of 3 instead of 2. (An attack where ANY land unit attacks a Japanese land zone from any sea zone by being transported by via by a sea transport unit or submarine).
5. On the **2nd game round only**, Japan may purchase the following units at a special cost

Japan	3 Regular Infantry units	2 IPU's each
Japan (Capital) Sea Zone	2 Destroyers	4 IPU's each

Japan has 2 situations that should they start losing the war, they may take advantage of.

1. KAMIKAZES: If the Japanese economy falls to 19 or below, then this rule takes effect. Kamikaze fighters on the first round of combat pick a target & roll their standard "to hit" dice. If the die result is a 1 then both units are removed from play regardless of how many hits are required to destroy the target. Any other "hit" result inflicts one damage point to the target. Whether the fighter hits or misses its target, it is then immediately removed from play. It is not counted as a casualty in the defense die rolls.
2. If the Japanese economy falls to 9 or less, the Japanese people start arming every man, woman & child, age 10 & up. This results in Japan being able to purchase regular infantry units for 1 IPU.

NOTE: Both of the above situations only apply if Japan has the applicable economy at the beginning of its turn. If on subsequent turns, the Japanese economy rises and no longer meets the above requirements, then the ability to take advantage of these situations is lost until the economy falls again. Japan's ability to purchase infantry units at 1 IPU cannot drop to 0 IPU's due to industrial technology.

Historical Background and Special Rules for each Country.

CHINA

CAPITOL: KIANGSI PROVINCE
GOVERNMENT: NATIONALISTS / COMMUNISM
RULER: CHIANG KAI CHEK



China, at this time in its history, is in great turmoil. The Nationalists, and the Communists are on the brink of civil war for supremacy of the country. At this time, however, the Nationalists have the upper hand. China has allowed USA advisors in its country to train its military, and there are rogue units in the south, China is as close as you can get to being at war with Japan because of the massacres and fighting near Mongolia. While China is grateful to Russia for its assistance in these battles, no alliance has been formally made. China has perfected the art of mobile special forces training camps, therefore, they do not specifically need an Industrial factory in a zone to create them. China has the following restrictions:

Special Rules for China:

1. Until China declares war against the Axis regime, The USA cannot deploy more than 2 ground and 2 air units on any zone of Chinese soil each. France and The U.K. Cannot deploy any units on Chinese soil until China declares war against the Axis regime.
2. China is allowed to relocate its capitol under the rules of capitol factory takeover.
3. China may not render lend lease to any nation ever.
4. China purchases Destroyer units at a cost of 6 IPU's instead of 8.
5. Chinese Special forces have no special ability, but may be built like Regular Infantry forces under the rules of building Infantry units without a factory.
6. China may purchase units directly from the USA at a cost of -1 IPU's under the following conditions:
 - A. USA Regular infantry units and Special Forces Units are not allowed to be purchased.
 - B. The USA land and air units are on Chinese Soil at the beginning of the China's turn.
 - C. The USA sea units are in a sea zone adjacent to Chinese Soil at the beginning of the China's turn.
 - D. The USA player agrees to the purchase.
 - E. The USA units are removed from the board during the purchase units phase of the turn, and returned as identical Chinese Units in the same location during the place units phase.
 - F. The USA receives all IPU income for these purchases.
7. China has no special 2nd turn only purchases like other nations.
8. China may not declare war on Russia unless Russia declares war on the allied regime first and declares itself an axis regime player.

Historical Background and Special Rules for each Country.

UNITED STATES (USA)

CAPITOL: EASTERN UNITED STATES
GOVERNMENT: DEMOCRATIC REPUBLIC
PRESIDENT: FRANKLIN D. ROOSEVELT



The United States of America is a country that is in a very pacifistic mode. The wounds of World War I have never healed, and the country is recovering from its greatest depression ever. The military is at its lowest strength in years, and beginning to become outdated. Only minor improvements have been made in military technology in the last five years. The USA is very desperate to avoid the growing tension in Europe at any cost. The USA has taken steps in the Pacific to aid other countries and does occupy several regions with troops and observers. When you look at the map, these zones are in a lighter shade of green than the rest of the USA's territories. The USA is in military control of these zones, but has the following restrictions until she declares war against the Axis regime.

1. The USA collects no IPU's income for its occupied territories. (lighter green)
2. The USA cannot build ANY units in these zones or the sea zones surrounding them.

Because of their government, the USA also has the following restrictions for the ENTIRE GAME!.

1. The USA can never conquer a neutral territory, they can attempt to get a neutral country to join them through diplomacy, or they can conquer a neutral country that has been taken by the Axis regime, or Russia, but only if they have declared war on the occupying nation.
2. The USA can spend up to 50% of its current economy on lend lease total. These funds can be split up anyway The USA chooses within the restrictions of the receiving nation. The USA may sell its units directly to the United Kingdom or China under the restrictions of the receiving nation. These purchases do not count as lend lease funds, and the IPU's gained do not count towards the calculation of the USA's economy to determine the amount it can lend lease.

The USA does enjoy certain benefits due to its status. These benefits also cover the ENTIRE game.

1. USA Special forces (Marines) are the only ground units that can attack on the first round of an amphibious assault. In an amphibious assault attack, these units attack on a die roll of 3 instead of 2.
2. The USA doesn't have to roll to kill spies. All spies found are considered captured and imprisoned for the duration of the war. Any spy unit found is simply removed from the board.
3. The USA purchases sea transport units at a cost of 4 IPU's instead of 6.

Other Special Rules for the USA.

1. Starting on the turn that they declare war against the Axis regime, the USA receives 1 free economic upgrade chip for every factory they own in the 5 original USA provinces still containing a factory unit. This effect last for 3 rounds or until the factory has the maximum number of chips it can possess.

Historical Background and Special Rules for each Country.

U.S.S.R. (RUSSIA)

CAPITOL: MOSCOW
GOVERNMENT: SOCIALISTIC REPUBLIC
RULER: JOSEPH STALIN



The U.S.S.R. (Russia) is the true wild card of the world. While 2 main factions exist in the world (Germany, Italy, Japan on one side, and England, France, USA and China on the other) due to their historical and political treaties, Russia is aligned to no one. Since the revolution on 1917, Russia has been in and out of a state of civil war for years. But now, a very strong leader, Joseph Stalin, is in charge of the country, and has the people at bay. Until Russia "picks a side to be on" it has non-aggression pacts with almost everybody. Due to its outdated technology, and costs of internal conflict, it would be quite expensive for it to convert itself into a war machine ready to compete with the world. Any nation may that can, may "lend lease" to Russia. The maximum any one nation can give to Russia until it declares war, is 5 IPU's per turn. Once it declares war, the maximum amount is raised to 10 IPU's per turn per nation, based on the restriction of the giving nation.

Russia also has the following restrictions until it declares war.

1. Russia may not attack a neutral country. It may attack a Nazi sympathizer country.
2. Russia may attempt a diplomatic takeover of a neutral country, but if the result is 4 or greater, it must retreat.
3. No other country may station any units on any Russian owned land zones.
4. Russia cannot attempt to conquer a neutral or Nazi sympathizer country that has been taken by any other player.
5. Russian Sea units cannot move INTO a sea zone containing ships from any other country.
6. Russian Sea units cannot move into a sea zone adjacent to any other players capitol zone. (ie.. Japan, Berlin, France, Eastern USA, England, or Italy).
7. Russia must maintain at the end of each of its turns, 1 ground unit per IPU for each of its' original land zones. (Ground units may consist of any Infantry units, armor, or APC units.) Failure to do so results in the loss of collecting that zones' IPU's during the collect income phase of their turn. (i.e. Moscow must maintain 4 ground units at the end of each Russian turn or Russia doesn't collect anything for the Moscow land zone.)
8. At the beginning of each of its turns, Russia must either surrender 1-8 IPU's (based on die roll) to maintain the peace internally within its people, or declare war on either the Axis or Allied regime.

Other Russian Special Rules:

1. Russia is allowed to relocate its capitol under the rules of capitol factory takeover.
2. Russia purchases Bomber units at a cost of 10 IPU's instead of 12.
3. Russian special forces use a combined arms special ability that when a Bomber Unit, a Regular Infantry unit, and a Special Forces Unit attack as a group, the Special Forces unit attacks on a die roll of 3 instead of 2.

Historical Background and Special Rules for each Country.

Neutral Countries and Minor Powers

CAPITOL: VARIOUS
GOVERNMENT: VARIOUS
RULER: VARIOUS



The neutral countries play a significant roll in this game, just as they did in the war itself. They are not loyal to any one major faction, as many of them have recently declared independence, and their governments are shaky at best.

Players may either try to conquer these countries, and collect their IPU's, or try to get them to join their cause through diplomacy. Diplomacy can take time, and the outcome is not certain, but it can greatly enhance or hinder a nations bid for supremacy in the world.

The neutral countries do not "get a turn" like the major factions in the game. They only come into play when a player tries to take over one of them.

They are 5 minor powers in the world. They are Spain, Belgium, The Netherlands, Denmark, and Portugal. Should one of these 5 nations fall to one of the major powers, the fate of their colonies must also be decided at that time. Some may also join the faction that conquered their capitol, some may declare independence, or some may choose to join the other side.

Special Rules for the Neutral Countries / Minor Powers.

1. Neutral Country / Minor power units may never leave their home country to attack another zone.
2. In a case where it is needed, the amount of Reserve Infantry units that a Neutral country / Minor Power has is determined by the roll of a 4-sided die. The number rolled on the die is the number of Reserve Infantry units that nation possesses. Reserve Infantry units for a Neutral country / Minor power are called into battle on round 1 of combat instead of round 2 like players' reserves.
3. In the case where a Minor Power country calls up its reserve units, the colony countries DO NOT automatically call up their reserve units.
4. If a Neutral Country / Minor Power country joins a major faction through diplomacy, the Neutral Country / Minor Power units in that country are exchanged for identical units belonging to the major faction. These units are considered the property of the major faction and may leave the country to fight elsewhere. They may not, however, move until the players' next turn.
5. If a Neutral Country / Minor Power country joins a major faction through diplomacy, the airports of that country are immediately open and considered friendly territory. A player may land their air units in this country during the non-combat movement phase of this turn.
6. If a Neutral Country / Minor Power country joins a major faction through diplomacy, the player collects the IPU value for this nation at the end of their turn. They may not, however, build any units in this zone until their next turn.
7. Rules 4-6 above also apply to any colony nations of a Minor Power country that joins a major faction or is taken by force, regardless of which side the colony nation joins. If the colony nation declares Independence, it is considered a neutral country from that point forward, and must comply with the rules of any other Neutral Country.

Detailed Description of the game units.

Regular Infantry units

Purchase Cost:	3 IPU's
Regular Attack factor:	1 (6-sided die)
Regular Defense factor:	2 (6-sided die)
Movement factor:	1 land zone
Air Transport:	1 load factor (non combat only)
Sea Transport:	1 load factor
Land Transport:	1 load factor

Standard rules for regular Infantry units.

1. Regular Infantry may move 1 land zone total per turn during either combat or non-combat movement phase. This action negates any other movement.
2. Regular Infantry Units may be loaded onto a sea transport and dropped onto a different land zone during either combat or non-combat movement phase. This action negates any other movement.
3. Regular Infantry Units may be loaded onto a transport plane unit and flown to a different land zone during non-combat movement phase only. This action negates any other movement.
4. Regular Infantry Units may be loaded onto a Armored personnel Carrier (APC) unit and dropped onto a different land zone during combat or non-combat movement phase. This action negates any other movement.
5. When conducting an amphibious assault, on the first round of combat, Regular Infantry Units do not get to roll an attack die. (They are considered to be landing on the beach.)
6. Regular Infantry Units may be built up to the limit of the factories' production level in any land zone containing a industrial factory.
7. Regular Infantry Units may be built in any original color land zone without a factory at a production limit equal to the land zones' IPU value.

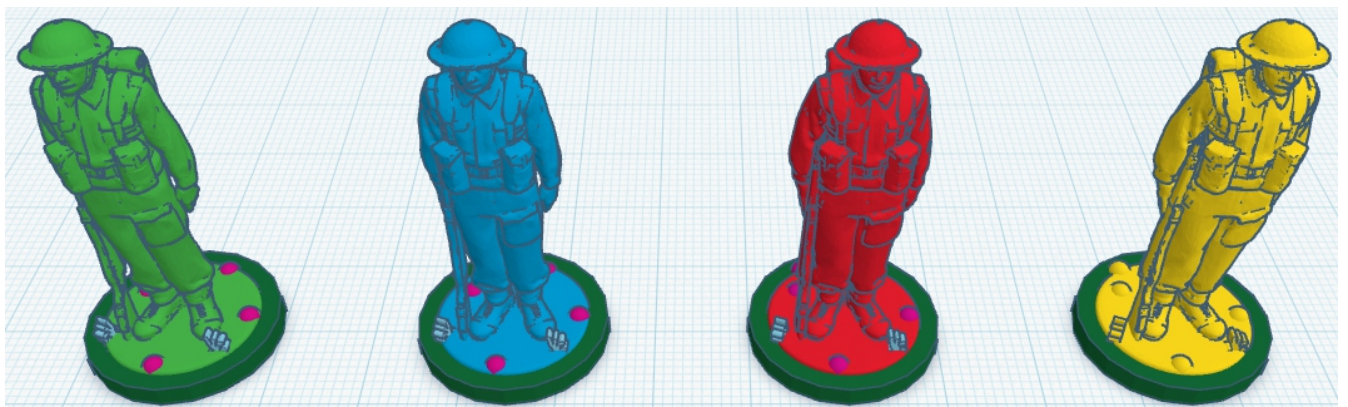

Detailed Description of the game units.

Special Forces Infantry units

Purchase Cost:	4 IPU's
Regular Attack factor:	2 (6-sided die)
Regular Defense factor:	2 (6-sided die)
Movement factor:	1 land zone
Air Transport:	1 load factor
Sea Transport:	1 load factor
Land Transport:	1 load factor

Standard rules for Special Forces Infantry units.

1. Special Forces Infantry may move 1 land zone total per turn during either combat or non-combat movement phase. This action negates any other movement.
2. Special Forces Infantry Units may be loaded onto a sea transport and dropped onto a different land zone during either combat or non-combat movement phase. This action negates any other movement.
3. Special Forces Infantry Units may be loaded onto a transport plane unit and flown to a different land zone during either combat or non-combat movement phase only. If this movement is performed during combat movement phase, the Special Forces unit and the Transport plane unit must begin the turn in the same zone, and the Special Forces unit is considered to be a paratrooper dropping into the new land zone. This action negates any other movement.
4. Special Forces Infantry Units may be loaded onto a Armored personnel Carrier (APC) unit and dropped onto a different land zone during either combat or non-combat movement phase. This action negates any other movement.
5. Special Forces Infantry Units may be loaded onto a submarine and dropped onto a different land zone during either combat or non-combat movement phase. This action negates any other movement.
6. When conducting an amphibious assault, on the first round of combat, Special Forces Infantry Units do not get to roll an attack die. (They are considered to be landing on the beach.) (The exception to this rule is the USA Special Forces unit)
7. Special Forces Infantry Units may be built up to the limit of the factories' production level in any land zone containing a industrial factory.
8. Chinese Special forces Infantry Units may be built in any original color land zone without a factory at a production limit equal to the land zones' IPU value.
9. Special Forces Infantry are the only units that may find, capture and/or kill spy units.

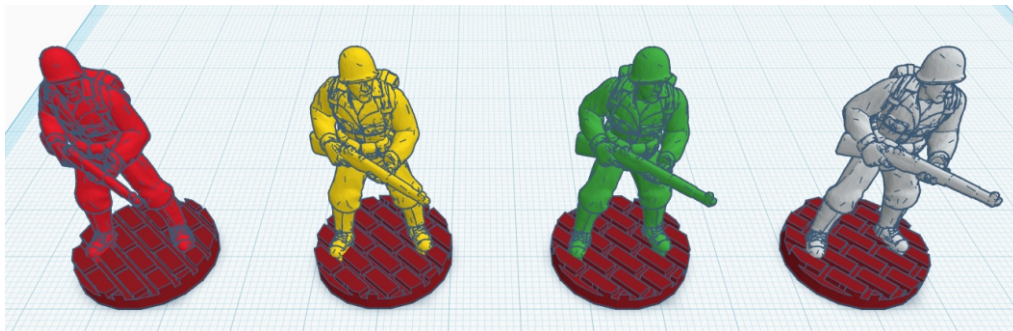

Detailed Description of the game units.

Reserve Infantry units

Purchase Cost:	3 IPU's
Regular Attack factor:	N/A
Regular Defense factor:	2 (6-sided die)
Movement factor:	Special
Air Transport:	N/A
Sea Transport:	N/A
Land Transport:	N/A

Standard rules for Reserve Infantry units.

1. Each country is allowed a maximum of 5 total Reserve Infantry Units at any given time.
2. Reserve Infantry units are never allowed to attack a target. They are used for defense only.
3. Reserve Infantry Units are built at a countries' capitol land zone and are designated by placing a Reserve Infantry unit in the zone (See picture) They are never moved during the game, except when called up to defend a land zone. They are not part of the regular garrison of units in a players' Capitol land zone.
4. At the very beginning of the SECOND or later combat round, a defending player may elect to call up the reserve Infantry units to a given battle. When this occurs, the defending player moves any or all of the Reserve Infantry units to the battle board in the Regular Infantry unit location. Players must keep separate track of these units from the rest of the Regular Infantry units. If at the end of all combat rounds, any of the Reserve Infantry units have not been eliminated, they are then returned to the Capitol land zone.
5. Reserve Infantry units may never be converted back to Regular Infantry units. Once a units is designated as a Reserve Infantry unit, it must remain so until it is either eliminated, or the end of the game.

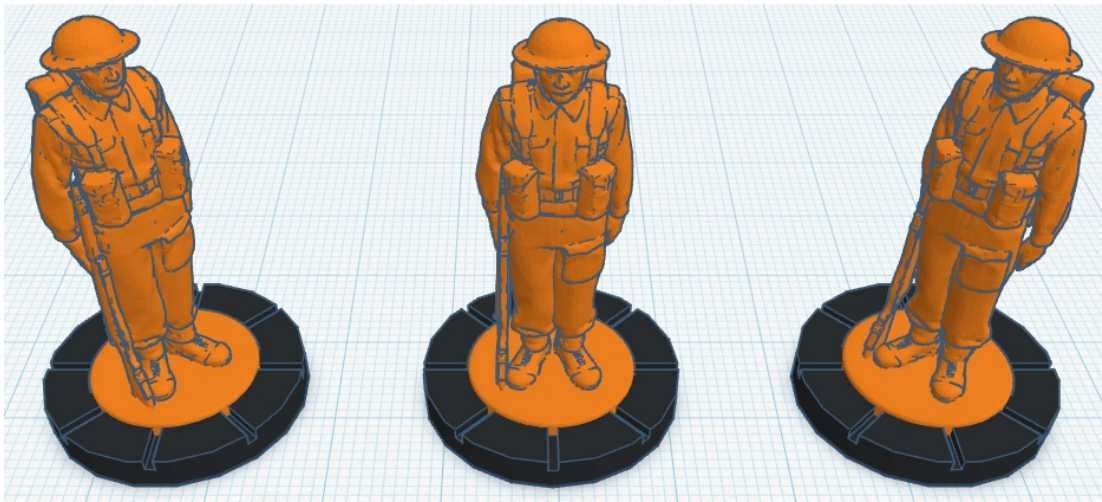

Detailed Description of the game units.

Armored Personnel Carrier (APC) units

Purchase Cost:	3 IPU's
Regular Attack factor:	N/A
Regular Defense factor:	1 (6-sided die)
Movement factor:	2 land zones
Air Transport:	N/A
Sea Transport:	2 load factors
Land Transport:	Carries 2 load factors

Standard rules for Armored Personnel Carrier (APC) units.

1. APC's may move up to 2 land zones total per turn during either combat or non-combat movement phase. This action negates any other movement.
2. APC's may be loaded onto a sea transport and dropped onto a different land zone during either combat or non-combat movement phase. APC's may not carry other units during this type of movement. This action negates any other movement.
3. APC's may be loaded with 0, 1, or 2 load factors of either Regular Infantry or Special Forces units while performing the movement in rule 1 above. Once the APC arrives at its final destination, any Regular Infantry or Special Forces Units are immediately removed from the APC into the new land zone.
4. If an APC moves only 1 zone during combat movement phase, and survives the combat phase of the turn, it may NOT move 1 more zone during the non-combat movement phase. It may not move under the guidelines in rule 2 above by sea transport.
5. APC's may be built up to the limit of the factories' production level in any land zone containing an industrial factory.
6. APC's may move through an unoccupied enemy land zone. This action does not constitute capturing the enemy zone that was moved through.

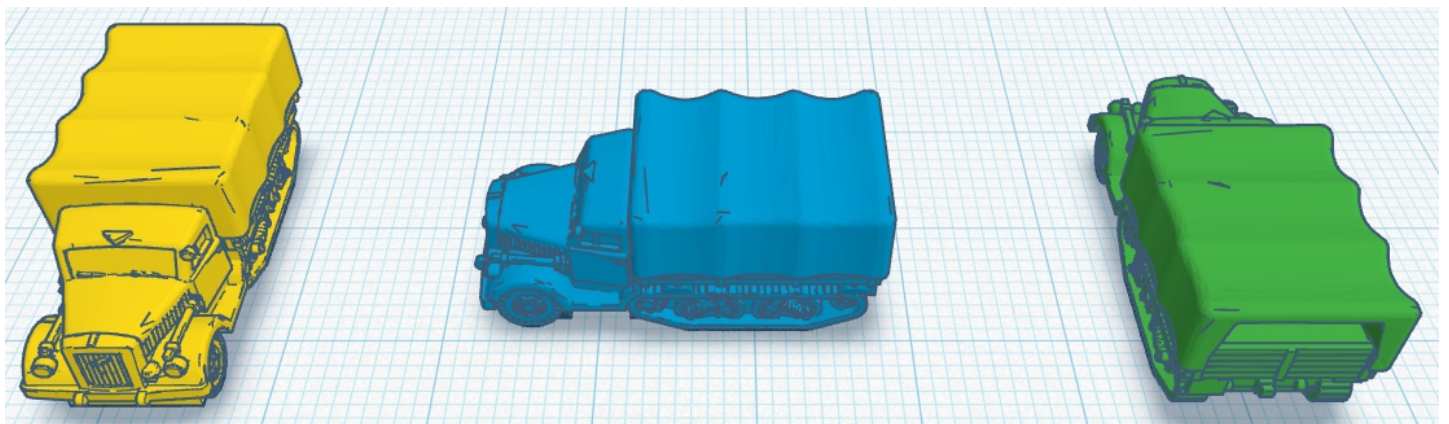

Detailed Description of the game units.

Armor (Tank) units

Purchase Cost:	5 IPU's
Regular Attack factor:	3 (6-sided die)
Regular Defense factor:	2 (6-sided die)
Movement factor:	2 land zones
Air Transport:	N/A
Sea Transport:	2 load factors
Land Transport:	N/A

Standard rules for Armor (Tank) units.

1. Armor units may move up to 2 land zones total per turn during either combat or non-combat movement phase. This action negates any other movement.
2. Armor units may be loaded onto a sea transport and dropped onto a different land zone during either combat or non-combat movement phase. This action negates any other movement.
3. If an Armor unit moves only 1 zone during combat movement phase, and survives the combat phase of the turn, it may NOT move 1 more zone during the non-combat movement phase. It may NOT move under the guidelines in rule 2 above by sea transport.
4. Armor units may move through an unoccupied enemy land zone. This action DOES NOT constitute capturing the enemy zone that was moved through.
5. When conducting an amphibious assault, on the first round of combat, Armor Units do not get to roll an attack die. (They are considered to be landing on the beach.)
6. Armor units may be built up to the limit of the factories' production level in any land zone containing an industrial factory.

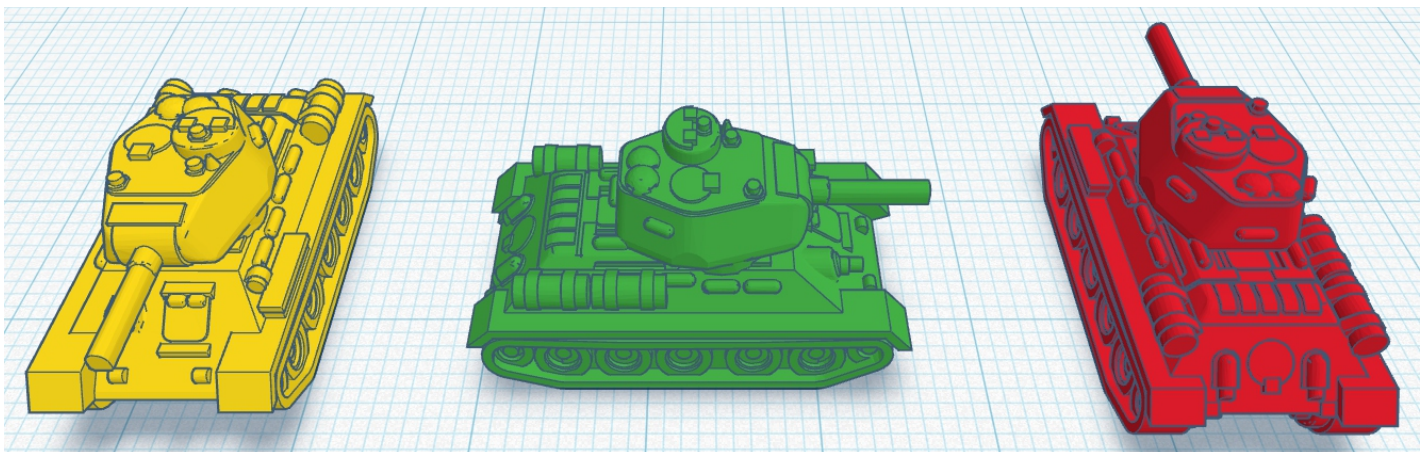

Detailed Description of the game units.

Fighter units

Purchase Cost:	10 IPU's
Regular Attack factor:	4 (8-sided die)
Regular Defense factor:	5 (8-sided die)
Movement factor:	4 zones
Air Transport:	N/A
Sea Transport:	1 load factor (Aircraft Carrier)
Land Transport:	N/A

Standard rules for Fighter units.

1. Fighter units may move up to 4 zones total per turn during either combat or non-combat movement phase. This action negates any other movement.
2. Fighter units must begin and end their turn in either a friendly land zone, or aboard a friendly Aircraft Carrier unit.
3. Fighter units may not be transported by Sea Transport or APC.
4. Fighter units are subject to AA/AA and Coastal gun defense rolls for any of these units they fly over during combat movement phase only.
5. Fighter units may be built up to the limit of the factories' production level in any land zone containing an industrial factory. They may not be built directly onto an Aircraft Carrier unit.

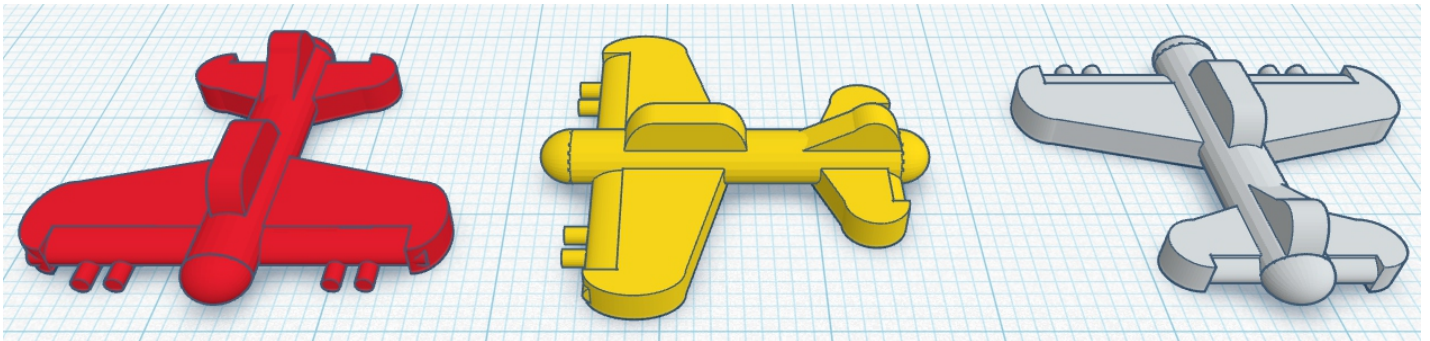

Detailed Description of the game units.

Transport Plane units

Purchase Cost:	8 IPU's
Regular Attack factor:	N/A
Regular Defense factor:	1 (8-sided die)
Movement factor:	4 zones
Air Transport:	Carries 2 load factors
Sea Transport:	3 load factors (Aircraft Carrier)
Land Transport:	N/A

Standard rules for transport plane units.

1. Transport Plane units may move up to 4 zones total per turn during either combat or non-combat movement phase. This action negates any other movement.
2. Transport plane units may only carry Special Forces units during the combat movement phase of a players' turn. This type of movement requires that both units start in the same location.
3. Transport plane units may carry Regular Infantry and/or Special Forces units during the non-combat movement phase of a players' turn. This type of movement does not require that both units start in the same location. (I.e. A transport plane load may start in a friendly land zone, fly 2 zones to another friendly land zone with 2 Infantry units, load these 2 units, and fly 2 more zones to a different friendly zone, and drop those units there and land.)
4. Transport planes may make multiple pick up and drop of missions during the non-combat phase of a players' turn only as long as it doesn't exceed its total movement allowance for a turn. (I.e. A transport plane load may start in a friendly land zone with 2 Regular Infantry units, load these 2 units, and fly 2 zones to a different friendly zone. It may then drop these 2 units, load 2 different Infantry units, fly up to 2 more zones to another friendly zone, and drop those units there and land.)
5. Transport plane units must begin and end their turn in either a friendly land zone, or aboard a friendly Aircraft Carrier unit. (The Aircraft carrier unit must be technologically advanced to accommodate the 3 load factors). While aboard the Aircraft Carrier unit, its complement of Infantry units are considered loaded, however, it may not leave the Aircraft Carrier unit without taking its Infantry units with it. In this instance, The Infantry units do not count towards the load factor capacity of the Aircraft Carrier unit.
6. Transport plane units may not be transported by Sea Transport or APC.
7. Transport plane units are subject to AA/AA and Coastal gun defense rolls for any of these units they fly over during combat movement phase only.
8. Transport plane units may be built up to the limit of the factories' production level in any land zone containing an industrial factory. They may not be built directly onto an Aircraft Carrier unit.

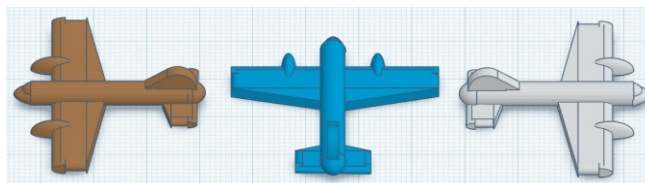

Detailed Description of the game units.

Bomber units

Purchase Cost:	12 IPU's
Regular Attack factor:	5 (8-sided die)
Regular Defense factor:	1 (8-sided die)
Movement factor:	6 zones
Air Transport:	carries 1 Atomic Bomb Unit
Sea Transport:	N/A
Land Transport:	N/A

Standard rules for Bomber units.

1. Bomber units may move up to 6 zones total per turn during either combat or non-combat movement phase. This action negates any other movement.
2. Bomber units must begin and end their turn in either a friendly land zone.
3. Bomber units may not be transported by Sea Transport or APC.
4. Bomber units are subject to AA/AA and Coastal gun defense rolls for any of these units they fly over during combat movement phase only.
5. Bomber units may employ 1 of 3 separate types of attacks. The Bomber unit may either attack units in the target zone directly, **OR** employ the dropping of an Atomic bomb unit **OR** employ an Economic Bombing Raid on an Industrial Factory Unit in the target zone. (See appendix C - Economic Bombing Raids)
6. Bomber units may be built up to the limit of the factories' production level in any land zone containing an industrial factory. They may not be built directly onto an Aircraft Carrier unit.

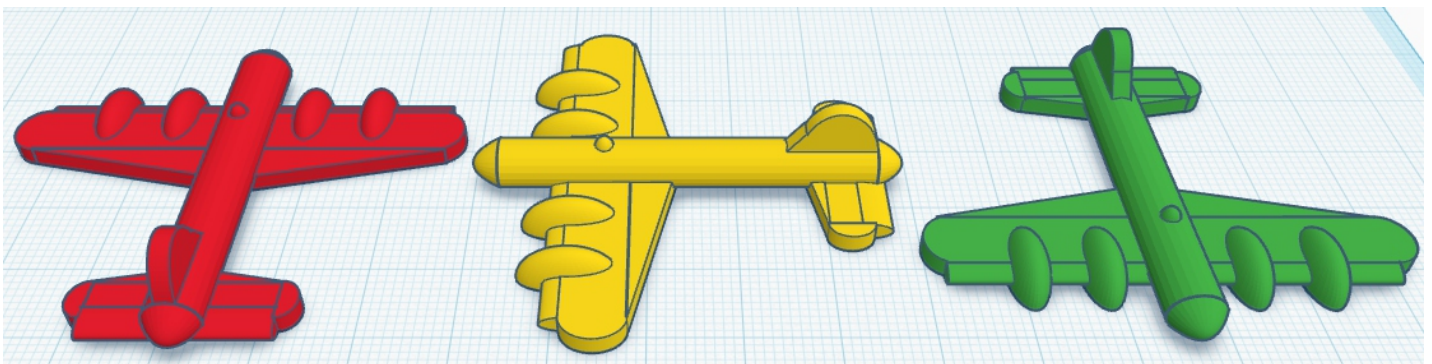

Detailed Description of the game units.

Sea Transport units

Purchase Cost:	6 IPU's
Regular Attack factor:	N/A
Regular Defense factor:	1 (10-sided die)
Movement factor:	2 zones
Air Transport:	N/A
Sea Transport:	Carries 2 load factors
Land Transport:	N/A

Standard rules for Sea Transport units.

1. Sea Transport units may move up to 2 sea zones total per turn during either combat or non-combat movement phase. If a Sea Transport unit moves during combat movement phase, it may not move during non-combat movement phase.
2. Sea Transport units have to be in a friendly sea zone adjacent to land units in order to load the land units onto the Sea Transport unit.
3. Sea Transport unit may only make 1 drop of land units onto 1 friendly or enemy land zone per turn. They may not continue moving after dropping units.
4. Sea Transport units may not enter an enemy sea zone alone as they have no attack capability. The battle for control of the enemy sea zone must take place before any units aboard the Sea Transport unit can be dropped off onto a friendly or enemy land zone. If the Sea Transport unit is taken as a casualty in the battle for control of the enemy sea zone, all units aboard the Sea Transport unit are considered lost. The Sea Transport unit and the units aboard the Sea Transport unit are considered as taking 1 casualty.
5. Sea Transport units cannot load and carry an Atomic Bomb unit.
6. Sea Transport units cannot be taken as a casualty in any land based attacks or amphibious assaults.
7. Sea Transport units are subject to Coastal gun defense rolls during any combat round of an amphibious assault attack if the Sea Transport unit dropped off any land units onto the land zone where the Coastal gun unit exists.
8. Sea Transport units may be built up to the limit of the factories' production level in any sea zone adjacent to a land zone containing an industrial factory.

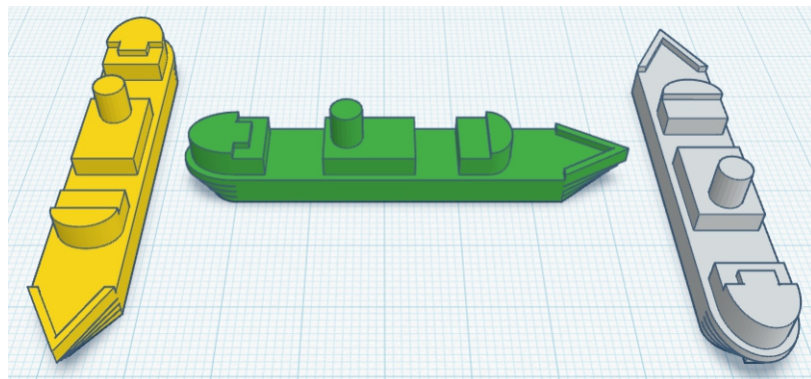

Detailed Description of the game units.

Submarine units

Purchase Cost:	8 IPU's
Regular Attack factor:	3 (10-sided die)
Regular Defense factor:	3 (10-sided die)
Movement factor:	2 zones
Air Transport:	N/A
Sea Transport:	Carries 1 load factor (Special Forces unit only)
Land Transport:	N/A

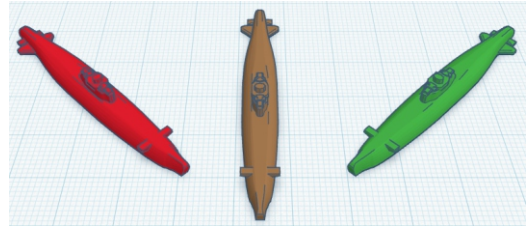

Standard rules for submarine units.

1. Submarine units may move up to 2 sea zones total per turn during either combat or non-combat movement phase. If a Submarine unit moves during combat movement phase, it may not move again during non-combat movement phase.
2. Submarine units have to be in a friendly sea zone adjacent to a land unit in order to load the land unit onto the Submarine unit. Submarine units may ONLY carry 1 Special Forces Infantry unit.
3. Submarine units may not continue moving after dropping units.
4. Submarine units may not drop Special Forces units onto a land zone from an enemy sea zone. The battle for control of the enemy sea zone must take place before any units aboard the Submarine unit can be dropped off onto a friendly or enemy land zone. If the Submarine unit is taken as a casualty in the battle for control of the enemy sea zone, the unit aboard the Submarine unit is considered lost. The Submarine unit and the unit aboard the Submarine unit are considered as taking 1 casualty.
5. Submarine units when on the attack in combat, have the unique ability of a “sneak” attack roll. This type of attack is good for every round of combat that a Submarine unit takes part in. If the submarine unit scores a “hit” on a unit, and the unit is destroyed as a result of the attack, that casualty is immediately removed from the board, and does not get to roll a defensive die roll.
6. On the FIRST round of combat only, submarine units are entitled to pick an individual target to attack.
7. Submarine units must add 2 to their defensive die rolls when defending against ONLY air units.
8. Submarine units cannot be taken as a casualty in any land based attacks or amphibious assaults.
9. Submarine units are subject to Coastal gun defense rolls during any combat round of an amphibious assault attack if the submarine dropped a land unit into the land zone where the Coastal gun unit exists.
10. Submarine units may be built up to the limit of the factories’ production level in any sea zone adjacent to a land zone containing an industrial factory.

Detailed Description of the game units.

Destroyer units

Purchase Cost:	8 IPU's
Regular Attack factor:	3 (10-sided die)
Regular Defense factor:	3 (10-sided die)
Movement factor:	2 zones
Air Transport:	N/A
Sea Transport:	N/A
Land Transport:	N/A

Standard rules for destroyer units.

1. Destroyer units may move up to 2 sea zones total per turn during either combat or non-combat movement phase. If a Destroyer unit moves during combat movement phase, it may not move again during non-combat movement phase.
2. Destroyer units are exempt from the Submarine "sneak" attack rule in that they still get to roll a defensive roll.
3. Destroyer units cannot be taken as a casualty in any land based attacks or amphibious assaults.
4. Destroyer units are never subject to Coastal gun defense rolls during any combat round of an amphibious assault attack as they cannot drop off units or attack through shore bombardment.
5. Destroyer units may be built up to the limit of the factories' production level in any sea zone adjacent to a land zone containing an industrial factory.

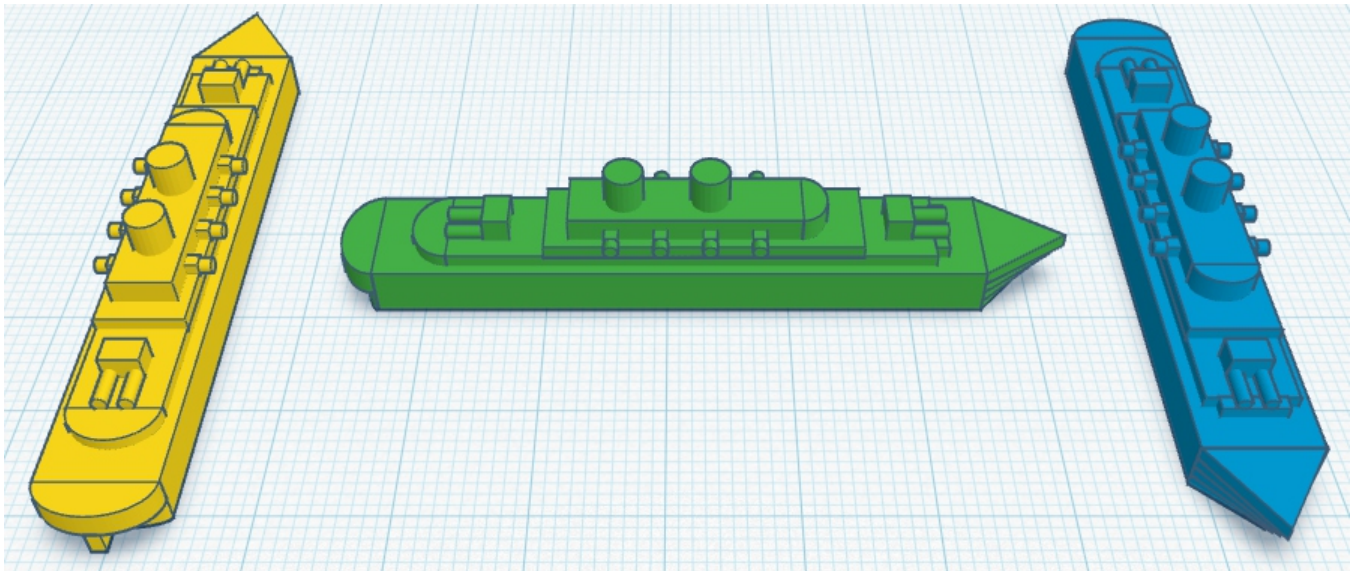

Detailed Description of the game units.

Cruiser units

Purchase Cost:	13 IPU's
Regular Attack factor:	5 (10-sided die)
Regular Defense factor:	5 (10-sided die)
Movement factor:	2 zones
Air Transport:	N/A
Sea Transport:	Carries 2 load factors (AA/AA gun or Atomic bomb only)
Land Transport:	N/A

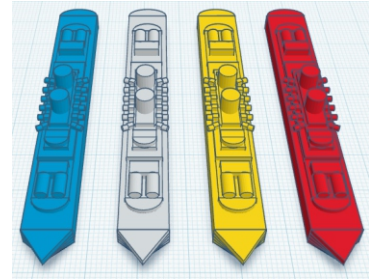

Standard rules for Cruiser units.

1. Cruiser units may move up to 2 sea zones total per turn during either combat or non-combat movement phase. If a Cruiser unit moves during combat movement phase, it may not move again during non-combat movement phase.
2. Cruiser units have to be in a friendly sea zone adjacent to a land unit in order to load the land unit onto the Cruiser unit. Cruiser units may ONLY carry 1 AA/AA gun unit OR 1 Atomic Bomb unit.
3. Cruiser units may not continue moving after dropping units.
4. Cruiser units may not drop units onto a land zone from an enemy sea zone. The battle for control of the enemy sea zone must take place before any unit aboard the Cruiser unit can be dropped off onto a friendly land zone. If the Cruiser unit is taken as a casualty in the battle for control of the enemy sea zone, the unit aboard the Cruiser unit is considered lost. The Cruiser unit and the unit aboard the Cruiser unit are considered as taking 1 casualty.
5. Cruiser units cannot be taken as a casualty in any land based attacks or amphibious assaults.
6. Cruiser units may fire a shore bombardment attack during the first round of combat during an amphibious assault. This attack is based on their current attack die roll. For every cruiser unit making this attack, there must be one land based unit being offloaded from a sea unit in the same sea zone as the cruiser unit, into the land zone being amphibiously assaulted.
7. Cruiser units are subject to Coastal gun defense rolls during the FIRST combat round of an amphibious assault attack if they attacked with a shore bombardment roll.
8. Cruiser units may be built up to the limit of the factories' production level in any sea zone adjacent to a land zone containing an industrial factory.

Detailed Description of the game units.

Aircraft Carrier units

Purchase Cost:	16 IPU's
Regular Attack factor:	1 (10-sided die)
Regular Defense factor:	3 (10-sided die)
Movement factor:	2 zones
Air Transport:	N/A
Sea Transport:	N/A
Land Transport:	Carries 2 air unit load factors.

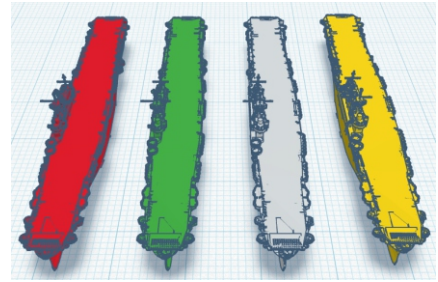

Standard rules for Aircraft Carrier units.

1. Aircraft Carrier units may move up to 2 sea zones total per turn during either combat or non-combat movement phase. If an Aircraft Carrier unit moves during combat movement phase, it may not move again during non-combat movement phase.
2. An Aircraft Carrier unit may not move from 1 sea zone to another sea zone without deploying all of its owned aircraft units from the ship. (This means that the aircraft units have to use some or all of their movement allotment to rejoin the Aircraft Carrier unit).
3. Aircraft Carrier units may carry aircraft from other friendly nations ONLY if both nations involved have declared war. Aircraft from other nations count against the load factor capability of the Aircraft Carrier unit. If the Aircraft Carrier unit moves into an enemy sea zone during combat movement phase, and is involved in an attack, the aircraft from the other friendly nation MAY NOT participate in the battle.
4. Aircraft Carrier units carry the equivalent of a Radar Unit on board at all times.
5. When an Aircraft Carrier is attacked, it must roll for the readiness status of its aircraft on board. This rule pertains to both owned and friendly aircraft aboard the Aircraft Carrier unit. (See appendix E - Aircraft Carrier readiness chart)
6. When an Aircraft Carrier unit is taken as a casualty in a battle, any aircraft on board the Aircraft Carrier unit are also considered as lost. All of these units are considered as taking 1 casualty.
7. Aircraft Carrier units cannot be taken as a casualty in any land based attacks or amphibious assaults.
8. Aircraft Carrier units are never subject to Coastal gun defense rolls during an amphibious assault attack as they cannot drop off units or attack through shore bombardment.
9. Aircraft Carrier units may be built up to the limit of the factories' production level in any sea zone adjacent to a land zone containing an industrial factory.

Detailed Description of the game units.

Battleship units

Purchase Cost:	20 IPU's
Regular Attack factor:	7 (10-sided die)
Regular Defense factor:	7 (10-sided die)
Movement factor:	2 zones
Air Transport:	N/A
Sea Transport:	Carries 2 load factors (AA/AA gun or Atomic bomb only)
Land Transport:	N/A

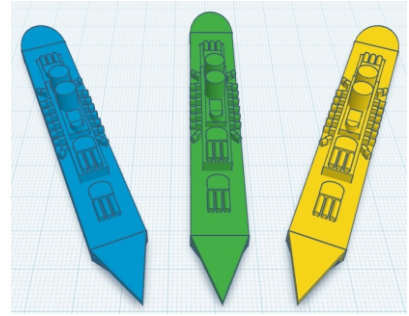

Standard rules for battleship units.

1. Battleship units may move up to 2 sea zones total per turn during either combat or non-combat movement phase. If a Battleship unit moves during combat movement phase, it may not move again during non-combat movement phase.
2. Battleship units have to be in a friendly sea zone adjacent to a land unit in order to load the land unit onto the Battleship unit. Battleship units may ONLY carry 1 AA/AA gun unit OR 1 Atomic Bomb unit.
3. Battleship units may not continue moving after dropping units.
4. Battleship units may not drop units onto a land zone from an enemy sea zone. The battle for control of the enemy sea zone must take place before any unit aboard the Battleship unit can be dropped off onto a friendly land zone. If the Battleship unit is taken as a casualty in the battle for control of the enemy sea zone, the unit aboard the Battleship unit is considered lost. The Battleship unit and the unit aboard the Battleship unit are considered as taking 1 casualty.
5. Battleship units cannot be taken as a casualty in any land based attacks or amphibious assaults.
6. Battleship units may fire a shore bombardment attack during the first round of combat during an amphibious assault. This attack is based on their current attack die roll. For every battleship unit making this attack, there must be one land based unit being offloaded from a sea unit in the same sea zone as the battleship unit, into the land zone being amphibiously assaulted.
7. Battleship units are subject to Coastal gun defense rolls during the FIRST combat round of an amphibious assault attack if they attacked with a shore bombardment roll.
8. Battleship units may be built up to the limit of the factories' production level in any sea zone adjacent to a land zone containing an industrial factory.

Detailed Description of the game units.

Anti-Aircraft / Anti-Armor Gun unit

Purchase Cost:	5 IPU's
Regular Attack factor:	N/A
Regular Defense factor:	1 (6-sided die)
Movement factor:	1 land zone
Air Transport:	N/A
Sea Transport:	2 load factors
Land Transport:	N/A

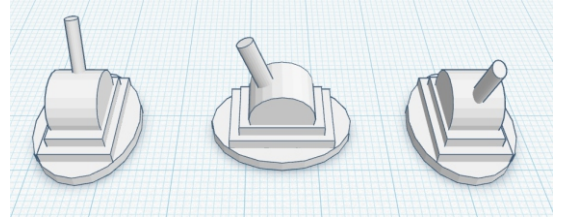

Standard rules for Anti-Aircraft / Anti-Armor Gun units.

1. AA / AA Guns may move 1 land zone total per turn during non-combat movement phase. This action negates any other movement.
2. AA / AA Guns may be loaded onto a sea transport and dropped onto a different land zone during non-combat movement phase. This action negates any other movement.
3. When a land zone is being attacked, The AA / AA Gun unit gets to roll its defense roll(s) at the beginning of the first round of combat only directly after shore bombardment rolls and casualty removal has been resolved (if any). The AA / AA Gun unit then rolls 1 defensive die roll for either each Armor (Tank) unit that is attacking the zone or each aircraft unit that is attacking the zone. Casualties for these rolls are removed before combat continues.
4. If the case of the AA / AA Gun unit rolling defensive die rolls against aircraft units, an active Radar unit allows the AA / AA Gun unit to defend at a die roll of 2 instead of 1 for each roll.
5. The AA / AA Gun unit is never taken as a casualty. It is captured by the attacking player and becomes one of the new players' units. The only way to destroy an AA / AA Gun unit is with the Spy unit.
6. The AA / AA Gun unit is limited in that there can never be more than one of these units on any land zone on the game board at any given time.
7. AA / AA Gun units may be built in any land zone containing an industrial factory.
8. Since AA/AA Gun defensive rolls take place in a players' turn after combat movement phase, but before the deploy Atomic Bomb section of the turn, all transport planes that are taken as a casualty by AA/AA gun fire are considered as having unloaded their units. If a transport plane flies over a land zone containing an AA/AA gun and is shot down prior to reaching its intended target land zone, all units inside the transport plane are considered lost as well. Any bomber unit carrying an Atomic Bomb unit that is shot down by an AA/AA unit is considered to have done so before the bomb was deployed.

Detailed Description of the game units.

Coastal Gun unit

Purchase Cost:	5 IPU's + 5 IPU's or 14 IPU's
Regular Attack factor:	N/A
Regular Defense factor:	1 (6-sided die) against land and air units. 4 (6-sided die) against sea units
Movement factor:	1 land zone
Air Transport:	N/A
Sea Transport:	N/A
Land Transport:	N/A

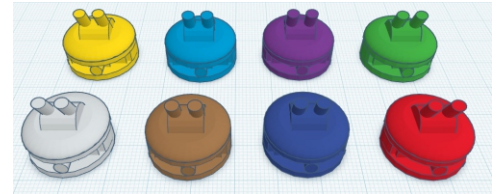

Standard rules for Coastal Gun units.

1. Coastal Guns may move 1 land zone total per turn during non-combat movement phase. The Cost to move this unit is 1 IPU's due to its size and the need to build a new enclosure.
2. Since the Coastal Gun unit is an upgraded AA/AA Gun unit, it retains all of the same capabilities of the AA/AA Gun unit except that it cannot be moved by Transport ship.
3. When a land zone is being attacked, The Coastal Gun unit gets to roll its defense roll(s) at the beginning of the first round of combat only directly after shore bombardment rolls and casualty removal has been resolved (if any). The Coastal Gun unit then rolls 1 defensive die roll for either each Armor (Tank) unit that is attacking the zone or each aircraft unit that is attacking the zone. Casualties for these rolls are removed before combat continues.
4. When a land zone containing a Coastal Gun is the subject of an amphibious assault attack, the Coastal Gun unit gets an extra attack factor. Directly after firing its AA/AA gun defense rolls, and the casualties for this fire are removed, the Coastal Gun unit then picks 1 sea unit that is involved in the amphibious assault. The player then rolls 1 defense roll (1-4 on a 6-sided die) to try to hit and or eliminate that particular sea unit. This defense roll exists for EVERY round of combat during the amphibious assault attack. (Please not that ships that are performing shore bombardment attack rolls are only subject to Coastal Gun defense rolls on the first round of combat only).
5. In the case of the Coastal Gun unit rolling defensive die rolls against aircraft units, an active Radar unit allows the Coastal Gun unit to defend at a die roll of 2 instead of 1 for each roll.
6. The Coastal Gun unit is never taken as a casualty. It is captured by the attacking player and becomes one of the new players' units. The only way to destroy a Coastal Gun unit is with the Spy unit.
7. The Coastal Gun unit is limited in that there can never be more than one of these units on any land zone on the game board at any given time. No Player may possess more than 3 of these units on the game board at any given time.
8. Coastal Gun units may be built in two different ways. A player may for the cost of 5 IPU's, upgrade any existing AA/AA gun into a coastal gun. If the purchase is made in this manner, the player simply removes the AA/AA gun unit from the board, and places a Coastal Gun unit in its place in the same location. A player may also for the cost of 14 IPU's build a coastal gun unit from scratch in any land zone containing an industrial factory.

Detailed Description of the game units.

Rocket Launcher units

Purchase Cost:	6 IPU's
Regular Attack factor:	Special
Regular Defense factor:	N/A
Movement factor:	1 land zone
Air Transport:	N/A
Sea Transport:	2 load factors
Land Transport:	N/A

Standard rules for Rocket Launcher units.

1. Rocket Launcher units may move 1 land zone total per turn during non-combat movement phase. This action negates any other movement or combat.
2. Rocket Launcher units may be loaded onto a sea transport and dropped onto a different land zone during non-combat movement phase. This action negates any other movement or combat.
3. As Rocket Launcher units only exist in the game based on the creation of them through technological advancement, their attack factor is based on which level of technology the player currently possesses. They are as follows:
 - Level 1 Rocket Launcher units fire up to 3 zones distance at a damage level of 1-6 IPU's
 - Level 2 Rocket Launcher units fire up to 4 zones distance at a damage level of 1-8 IPU's
 - Level 3 Rocket Launcher units fire up to 5 zones distance at a damage level of 1-10 IPU's
4. Rocket Launcher units may only attack enemy Industrial Factory Units. Their damage results in the immediate removal of IPU's from the enemy players' IPU pool allocation for their next turn.
5. Level 1 Rocket Launcher units' weapons are vulnerable to both Radar detection and AA/AA gun defense fire. Level 2 and level 3 Rocket Launcher units' weapons hit automatically.
6. The Rocket Launcher unit is limited in that there can never be more than one of these units on any land zone on the game board at any given time.
7. Rocket Launcher units may be built in any land zone containing an industrial factory.
8. Firing a Rocket Launcher does not destroy the unit and may be fired once each turn.

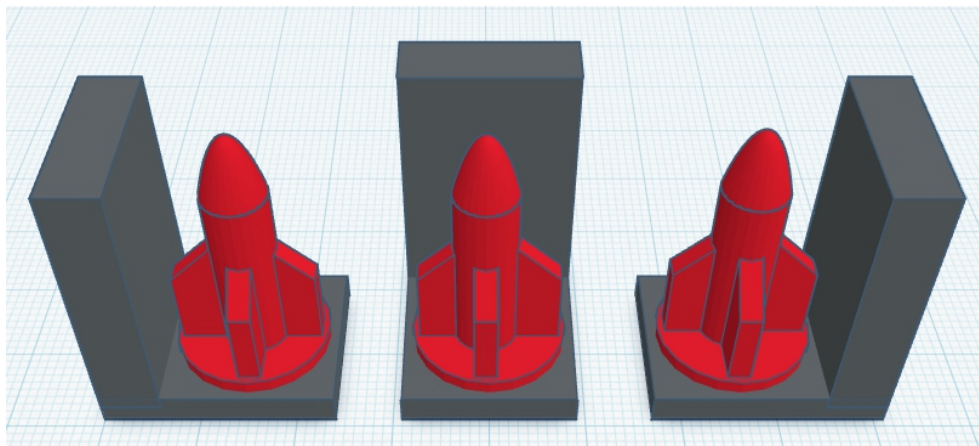

Detailed Description of the game units.

Radar units

Purchase Cost:	1 IPU
Regular Attack factor:	N/A
Regular Defense factor:	N/A
Movement factor:	N/A
Air Transport:	N/A
Sea Transport:	N/A
Land Transport:	N/A

Standard rules for Rocket Launcher units.

1. Radar Units, once built, may never move.
2. Radar units have no attack or defense capability.
3. Radar units are never taken as a casualty when a zone is attacked, they are considered captured by the attacking player. The only unit that can destroy a Radar Unit is a Spy Unit.
4. The purpose of Radar Units is to alert zones on the board to an impending attack from enemy air units and Level 1 Rocket Launcher Unit attacks. When one of the above mentioned units travels within 1 zone of a radar unit, the Radar unit rolls to see if it detects the incoming attack. If the Radar Unit is successful in detecting the attack (A roll of 1-2 on a 6-sided die), 2 individual occurrences happen. 1. Any of the players fighter units within 1 zone of the radar unit may travel to the zone where the radar unit is located to defend that zone, unless the zone where the fighter unit is located is also under attack. 2. Any of the players AA/AA gun units within 1 zone of the zone where the Radar unit is located now defend on a die roll of 2 instead of 1. If a Radar units 1 zone radius is violated by enemy air or Rocket attacks from more than 1 zone, the Radar unit gets 1 die roll for each zone violated. If ANY of the resulting die rolls is successful, then all units that are attacking are detected. If the above attacking units travel through a zone that violates 2 or more Radar units 1 zone radius at the same time, each Radar unit gets the opportunity to roll for detection.
5. Radar Units may be built in any friendly land zone. There can never be more than 1 on these units in any land zone on the board at any given time. Players may purchase a maximum of 1 Radar unit per turn.

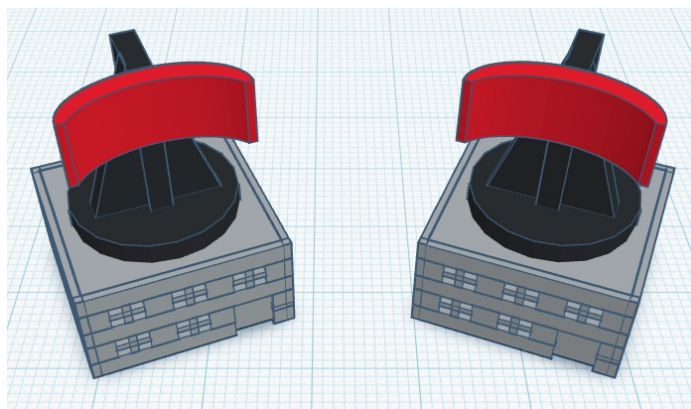

Detailed Description of the game units.

Spy units

Purchase Cost:	2 IPU's
Regular Attack factor:	Special
Regular Defense factor:	Special
Movement factor:	1 zone
Air Transport:	1 load factor
Sea Transport:	1 load factor
Land Transport:	1 load factor

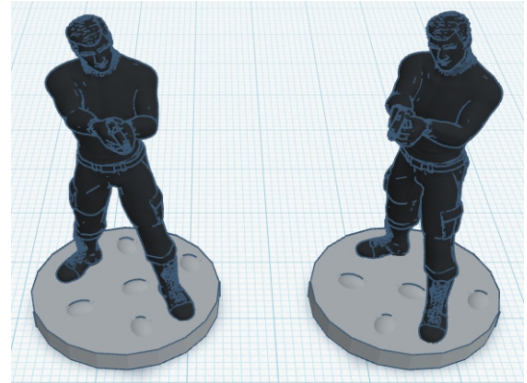

Standard rules for Spy units.

1. Spy units only move during combat movement phase. They may not move during the turn that they are purchased.
2. Spy units may be moved by Transport Ship, Transport Plane, Submarine, or APC units with the same restrictions and rules as when moving a Special Forces Infantry Unit, with the exceptions noted in rule 1 above.
3. A Spy unit, when purchased, may be built on ANY land zone on the entire game board, regardless of who owns the land zone in question. Players may only purchase 1 Spy unit per turn.
4. Spy units may only be captured or killed by Special Forces Infantry units. See Appendix ____ Capturing and/or Destroying Spy units.
5. A Spy unit may conduct any 1 of the follow missions per turn.
 - A. Conduct enemy sabotage on an Industrial Factory Unit.

In this mission, the Spy unit rolls an 8-sided die. If the die roll is a 1 or 2, the spy is successful in his mission. The result is as follows.

 1. If the Industrial factory has any economic upgrade chips, remove 1 chip.
 2. If the Industrial factory has no economic upgrade chips, the factory is either downgraded or removed. (An unlimited production factory becomes a limited production factory. A limited production factory is destroyed)

This mission may not be conducted on a Capital Production factory that has no economic upgrade chips.
 - B. Conduct enemy sabotage on an Radar Unit.

In this mission, the Spy unit rolls an 8-sided die. If the die roll is a 1 or 2, the spy is successful in his mission. The Radar unit is destroyed.
 - C. Conduct enemy sabotage on an Coastal Gun or AA/AA gun Unit.

In this mission, the Spy unit rolls an 8-sided die. If the die roll is a 1 or 2, the spy is successful in his mission. The Coastal Gun or AA/AA gun unit is destroyed.

CONTINUED NEXT PAGE

Standard rules for Spy units. (cond.)

D. Conduct enemy sabotage on an Rocket Launcher Unit.

In this mission, the Spy unit rolls an 8-sided die. If the die roll is a 1 or 2, the spy is successful in his mission. The Rocket Launcher unit is destroyed.

E. Steal Enemy Technology

In this mission, the Spy unit must be located in an Enemy Players Capital Land zone. The Spy unit then rolls an 8-sided die. If the die roll is a 1, the spy is successful in his mission. The Player may now add ANY 1 technology that the enemy player possesses, but only at level I technology level regardless of what level the enemy player possesses of that technology. The effects of this technology for the current player are immediate, however, the player may not go back to a different phase in his/her turn to take advantage of these benefits.

F. Sabotage Enemy Technology

In this mission, the Spy unit must be located in an Enemy Players Capital Land zone. The Spy unit then rolls an 8-sided die. If the die roll is a 1, the spy is successful in his mission. The Player may now reduce ANY 1 level II technology that the enemy player possesses back to a level I technology. The player may not reduce a level III technology back to a level II technology.

G. Assist Economic Bombing Raids.

See Appendix C for rules on how a Spy unit conducts this mission.

Detailed Description of the game units.

Atomic Bomb units

Purchase Cost:	12 IPU's (+6 IPU's)
Regular Attack factor:	Special
Regular Defense factor:	N/A
Movement factor:	N/A
Air Transport:	Special
Sea Transport:	Special
Land Transport:	N/A

Standard rules for Atomic Bomb units.

1. Atomic Bombs units may only be deployed to attack during combat movement phase by a Bomber Unit, OR transported from 1 land zone containing an Industrial Factory unit to another land zone containing an Industrial Factory Unit by a Bomber, Cruiser, or Battleship unit during non-combat movement phase. No other type of movement is allowed for this unit.
2. Atomic bomb units have no defense capability, and cannot be captured. They must be taken as a casualty like any other regular unit, and be destroyed before the land zone in which they are located can be conquered.
3. Players are not allowed to possess more than 3 Atomic Bomb units at any given time.
4. When an Atomic Bomb unit is deployed to attack, the bomber unit must simply reach its target zone (surviving any AA/AA gun or Coastal Gun Attacks) and declare the unit dropped. The effects of this attack are as follows:

Land Zone Attack:

1. All units in this zone must make a saving roll. The owning player rolls an 10-sided die for EACH unit in the zone. On a die roll of 1, the individual unit has survived the attack. All units that do not make their saving roll are destroyed. All surviving units must retreat from this land zone to an adjacent friendly land zone. Those units which cannot retreat are also destroyed.
2. The IPU Value of this land zone drops to 0 for the remainder of the game.
3. No units may enter, travel through, or fly over this land zone for 4 complete game rounds. (I.E. Until the beginning of the same players turn who dropped the Atomic Bomb unit's turn in the 4th round of play). A radiation marker is placed on the zone and remains until the four round time is completed.

CONTINUED NEXT PAGE



Standard rules for Atomic Bomb units. (cond.)

Sea Zone Attack:

1. All units in this zone must make a saving roll. The owning player rolls an 8-sided die for EACH unit in the zone. On a die roll of 1 or 2, the individual unit has survived the attack. All units that do not make their saving roll are destroyed. All surviving units must retreat from this sea zone to an adjacent friendly sea zone. Those units which cannot retreat are also destroyed. If a unit is destroyed, while it is carrying land units, the land units are also automatically destroyed. If a unit is destroyed, while it is carrying air units, the air units, if they survive their saving throw, may retreat to any adjacent friendly land or sea zone if applicable.
 2. No units may enter, travel through, or fly over this sea zone for 1 complete game round. (I.E. Until the beginning of the same player's turn who dropped the Atomic Bomb unit's turn in the next round of play)
5. The cost to deploy an Atomic Bomb Unit on an enemy player's Capital Land Zone is 10 IPU's. This cost must be paid at the time the unit is deployed.
 6. Players may only build 1 Atomic Bomb Unit per turn. The IPU cost to build these units increases by 6 IPU's per unit built. Atomic Bomb Units may only be built in a land zone containing an Unlimited or a Capital Industrial Factory unit.

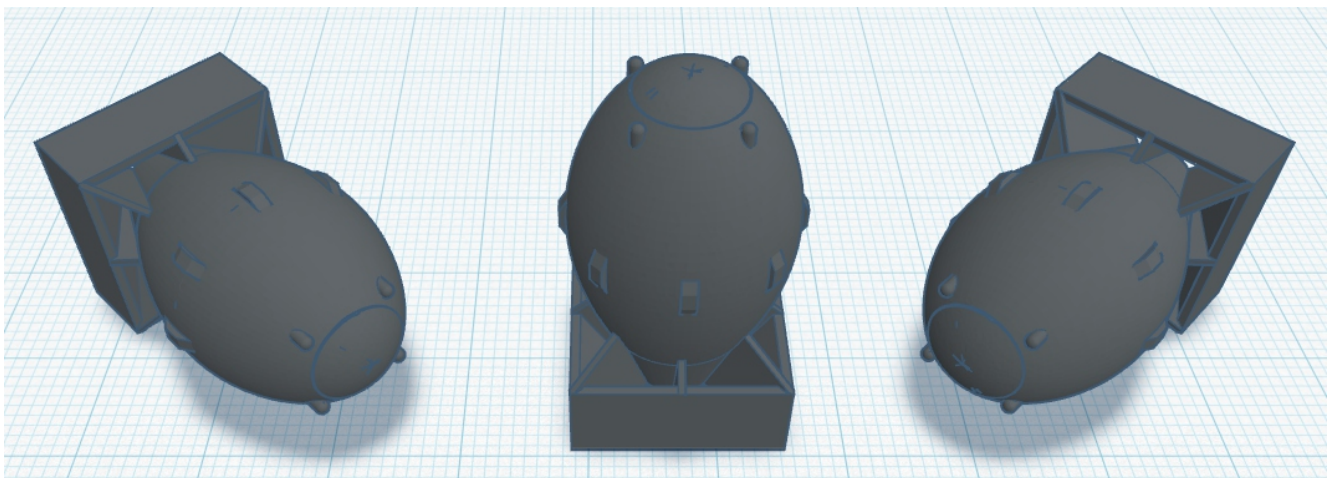

Detailed Description of the game units.

Industrial Factory units

Purchase Cost:	10 IPU's (+5 IPU's)
Regular Attack factor:	N/A
Regular Defense factor:	N/A
Movement factor:	N/A
Air Transport:	N/A
Sea Transport:	N/A
Land Transport:	Special

Standard rules for Industrial Factory units.

1. There are 3 type of Industrial Factory units. Each has a different production capability. The 3 types are as follows:
 - A: Limited Production Factories.
 1. Unit is a small white factory unit.
 2. Production is limited to the IPU value of the land zone plus the number of Economic Upgrade chips under the factory in total units.
 3. Limited Production factories may be moved during non-combat movement phase from land zone to an adjacent friendly land zone at a cost of 3 IPU's plus 1 IPU for every Economic Upgrade chip under the Factory Unit. A Factory that is moved cannot build new units in the same turn.
 4. Limited production Factories may be destroyed during the Place Units phase of a players turn for a cost of 3 IPU's plus 1 IPU for every Economic Upgrade chip under the Factory Unit.
 5. Limited Production Factories may have a maximum of 3 Economic Upgrades chips.
 - B: Unlimited Production Factories.
 1. Unit is a small player colored factory unit.
 2. Production is limited to the IPU value of the land zone plus the number of Economic Upgrade chips under the factory in total units for each Unit type class. (Land, Air, Sea, and Misc.
 3. Unlimited Production factories may be moved during non-combat movement phase from land zone to an adjacent friendly land zone at a cost of 5 IPU's plus 1 IPU for every Economic Upgrade chip under the Factory Unit. A Factory that is moved cannot build new units in the same turn.
 4. Unlimited production Factories may be destroyed during the Place Units phase of a players turn for a cost of 5 IPU's plus 1 IPU for every Economic Upgrade chip under the Factory Unit.
 5. Unlimited Production Factories may have a maximum of 6 Economic Upgrades chips.
 6. Players may only possess a maximum of 5 of these units on the board.

CONTINUED NEXT PAGE

Standard rules for Industrial Factory units. (cond.)

C: Capital Production Factories.

1. Unit is a Large player colored factory unit.
 2. Production is limited by the amount of IPU's the player possesses.
 3. Capital Production Factories may not be relocated unless captured. (Section 3.10 Capital Production Factory takeover.)
 5. Capital Production Factories may have a maximum of 10 Economic Upgrades chips.
-
2. Industrial Factory Units may only be built in a land zone that was owned by the player at the beginning of their turn. (Zones acquired by diplomacy do not count for this purpose.)
 3. Players may only build limited production factories or upgrade existing limited production factories to unlimited production factories at a cost of 5 IPU's.
 4. Players are limited in investing a maximum of 2 Economic Upgrade chips to any factory in a turn. They may invest in any or all factories they own.
 5. Players may invest Economic upgrades in the same turn they are converting a limited production factory into an unlimited production factory.
 6. Players may not build units on a land zone that they built an Industrial Factory at on the same game turn. (Except units that do not require an Industrial Factory unit to be built).

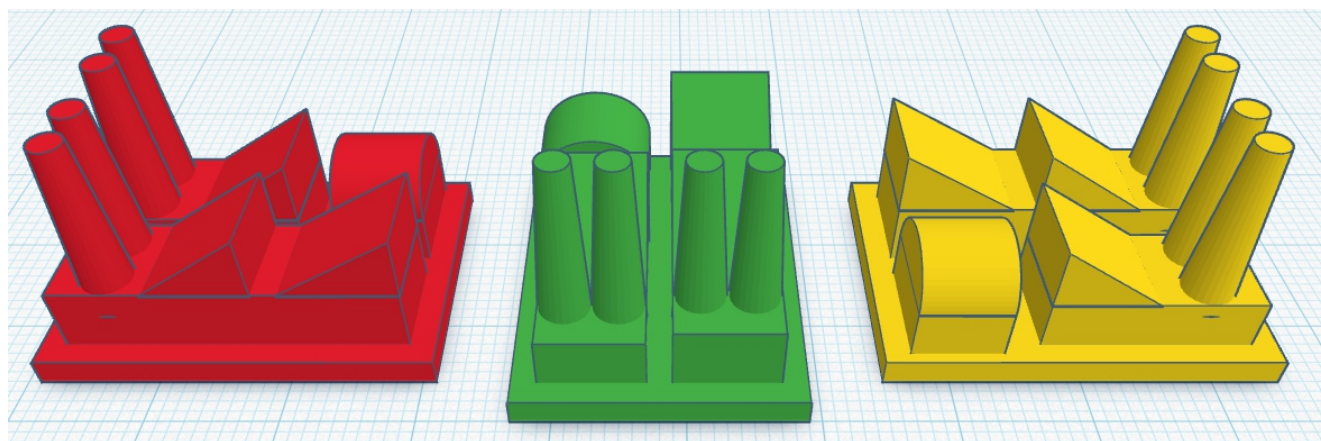
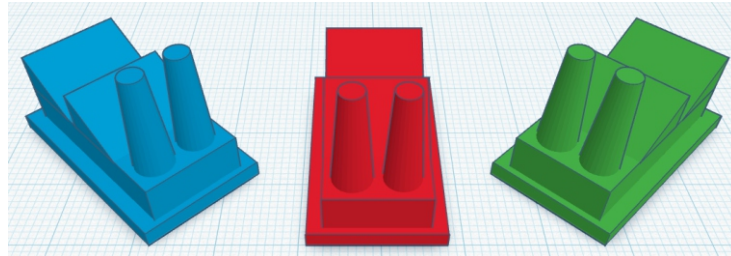
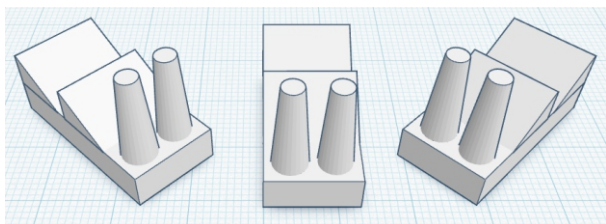

Detailed Description of the game units.

Country Markers

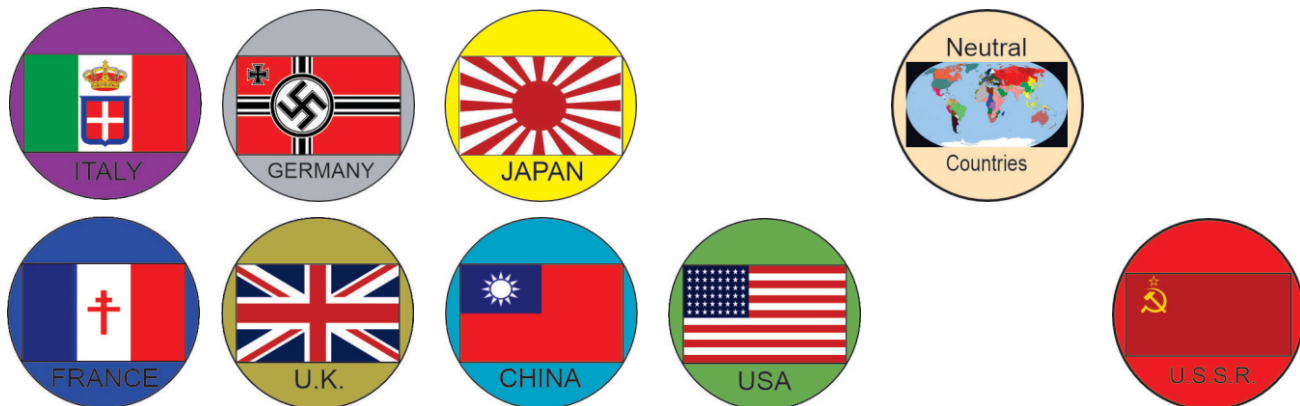

Standard rules for Country Markers

1. There are 9 standard country markers included in the game (See above)
These units are used to mark all territories that have been conquered by a player either by force or by diplomacy. They are also used to mark spy units belonging to a player that is located in another player's or a neutral country's territory.

Section 3.0 - Detailed description of each players' turn.

This section of the rule book will go into detail what happens during a players turn, and in what order it happens. Each of the major factions in the game gets 1 turn per game round. There is no set time in history as to what a game round represents, but it is approximately 6-9 weeks. Each player during a turn may or may not perform all of the sections of a game turn. Please note that the 12 phases of a players' turn must be performed in order. Once a player begins a certain phase, they cannot go back and make changes to a decision they made in a previous phase.

Section 3.1 - Declare War.

At the beginning of the game, there are 3 groups of factions existing in the world. The Axis faction, made up of Germany, Italy, and Japan. The Allies faction, made up of France, The United Kingdom, China, and The USA. Lastly, there is Russia, who due to internal conflicts, is totally neutral. None of these 3 groups have formally declared war as of yet, but tensions are very high in the world. There are certain restrictions that each player must abide by unless they declare war on the opposing group of nations. There is a cost factor involved in declaring war on another country. Factories must be converted from peace time production to war time production. Enlistment has to rise or a draft needs to be enacted. Training camps, ammunition, and other purchases will have to be made. To reflect these costs, each nation must pay the following cost in IPU's to declare war. As each government is different, the cost is different as well.

Germany to declare war on the Allied regime:	03 IPU's.
Italy to declare war on the Allied regime:	N/A
Japan to declare war on the Allied Regime:	08 IPU's.
France to declare war on the Axis Regime:	26 IPU's.
The United Kingdom to declare war on the Axis Regime:	38 IPU's.
China to declare war on the Axis Regime:	12 IPU's.
The USA to declare war on the Axis Regime:	52 IPU's.
Russia to declare war on the Axis regime and join the Allies:	31 IPU's.
Russia to declare war on the Allied regime and join the Axis:	38 IPU's.

There are situations in the world that will lower these costs. They are as follows:

Situations that lower an Allied regime Nation's cost to declare war:

Axis nation declares war on the Allies:	- 08 IPU's.
Axis nation attacks a neutral or Minor Power country:	- 02 IPU's.
Axis nation attacks any allied sea unit or land zone it has declared war against: (Germany Annexing a Nazi Sympathizer country has no effect on declaring war)	- 10 IPU's.

Situations that lower an Axis regime Nation's cost to declare war:

Allied nation declares war on the Axis:	- 02 IPU's.
Allied nation attacks a neutral or Minor Power country:	- 01 IPU's.
Allied nation attacks any Axis sea unit or land zone it has declared war against:	- 03 IPU's.

Each of these above situations is cumulative for each Nation in the effected Regime. The cost to declare war for any nation cannot drop below 0 IPU's.

The cost for any Axis or Allies regime nation (except Italy) to declare war on Russia is 10 IPU's. There is no situation to reduce this cost factor.

The above costs DO NOT effect Russia's costs to declare war. The only effect on Russia's cost to declare war on either the Axis or Allies regimes are:

Allied nation declares war on Russia:	- 05 IPU's to declare war on Allies.
Allied nation attacks Russia at sea:	- 05 IPU's to declare war on Allies.
Allied nation attacks Russia on land:	- 08 IPU's to declare war on Allies.
Axis nation declares war on Russia:	- 03 IPU's to declare war on Axis.
Axis nation attacks Russia at sea:	- 05 IPU's to declare war on Axis.
Axis nation attacks Russia on land:	- 08 IPU's to declare war on Axis.

Each of these situations is cumulative toward that particular regime.

Russia must keep track separately of how much it costs to declare war either against the Axis regime the Allies regime. The cost to declare war against either regime cannot drop below 0 IPU's. If Russia declares war and joins a regime where a nation of that regime has declared war against Russia, the previous declaration of war against Russia is dropped. Russia cannot declare war and join a regime when 2 or more nations in that particular regime have declared war against Russia. If 2 or more nations of each regime declare war against Russia before it has declared war, Russia must remain neutral for the rest of the game and is then automatically considered to be at war against all nations. (Note: Italy does count as a nation at war with Russia should Germany declare war against Russia)

Limitations on all nations until they declare war.

1. A major faction nation may not attack an opposing major faction nation unless war is declared.
2. Aircraft from a major factor nation may not fly over an opposing major faction nation unless war is declared.
3. A major faction nation sea unit may not enter a sea zone containing a sea unit from an opposing major faction nation unless war is declared.
4. War must be declared from attacking side only to lift the limitations in rules 1-3 above.
5. A major faction nation may place a Spy unit in a land zone belonging to an opposing major faction nation, but it may not conduction any missions without a declaration of war against that nation.

Section 3.2 - Develop Technology.

During this phase of a player's turn, players try to improve their units' capabilities by developing new or upgrading existing technology. There are 4 types of technology rolls that a player may engage in. Players may spend up to 10 IPU's per turn on this phase or up to 25% of their total IPU economy, whichever is greater. The only time a player cannot attempt these roll(s) is when they cannot or do not repair the damage from an Economic Bombing Raid attack under the Technology/Radar category. (See Appendix "C" EBR rules and chart).

The 4 types of technology rolls are as follows.

3.2.1 - Free Technology roll.

This roll is given to every player to have 1 free attempt at technology. This technology roll represents when a civilian developed a new technology during the war and gave it to their government. (Yes, that actually happened a few times). If a player rolls on the technology chart and the result is equal to a technology they already possess, they must re-roll the die.

3.2.2 - Standard Technology roll.

This roll is exactly the same as the free technology roll, except the player must pay 5 IPU's for each individual roll. It represents historically when governments paid companies or created agencies of the government to develop new things to aid in the war. If a player rolls on the technology chart and the result is equal to a technology they already possess, they must re-roll the die.

3.2.3 - Elevated Technology roll.

This type of technology roll involved technology that already exists somewhere in the world that a player wishes to try to copy. Sources for this technology came from photographs from civilians on vacation, spies, left over munitions in the field on a dead soldier, etc. The cost for this roll is 5 IPU's each as well. Players who employ this roll and are successful must randomly roll from the existing technologies known in the world (that they currently don't possess) rather than from all the technologies on the chart.

3.2.4 - Upgrade Technology Roll.

This type of roll is dedicated to upgrading a certain technology that a player currently possesses to the next level on the chart. There are 3 levels of technology for all 15 types of technology in the world that can be developed. This type of roll also costs 5 IPU's. Players must declare which technology they are trying to upgrade before they roll the die, and cannot make more than 1 attempt to upgrade the same technology in a turn.

Technology Roll Chart.

<u>Roll Type</u>	<u>Die Type</u>	<u>Successful Die Roll</u>	<u>Effect</u>
Free Technology Roll.	6-Sided	6 only.	Player gains 1 new random Level 1 Tech.
Standard Technology Roll.	6-Sided	6 only.	Player gains 1 new random Level 1 Tech.
Elevated Technology Roll.	8-Sided	7 or 8 only.	Player gains 1 new random Level 1 Tech.
Upgrade Technology Roll.	6-Sided	6 only.	Player may upgrade 1 Technology 1 level.

Section 3.2 - Develop Technology. (cond.)

To determine which new technology a player has developed in the case of a free or standard technology die roll, the player must roll two 8-side dice and consult the chart in Appendix B. If the result of the dice roll is a technology that the player already possesses, the player must re-roll the dice.

Notes to Technology Chart In Appendix “B”

1. Industrial Technology Level I does not include purchases of Radar Units / Economic Upgrade Chips / Sea Search Planes / Escort Fighter Planes / Technology Dice Rolls / or Atomic Bomb Units.
2. All Level III Technology Sea Units may now move up to 3 sea zone per turn.

Section 3.3 - Repair Damage from an EBR Attack.

If a player has been the subject of an Economic Bombing Raid (EBR) attack between the previous turn and the current turn, it is at this time that this damage can be repaired. Repairing this damage is optional based on the needs of the player for the current turn. If, for example, a player has taken damage to their shipyards, but has no need to build sea units this turn, then repairing the shipyards may not be a priority this turn.

To repair any damage, consult the chart in Appendix C - EBR Damage Chart. A player must pay 2 IPU's to repair 1 damage level in any single category. Players may repair as much damage as they desire, limited to their economy at the time. To repair an Industry selection back to “full” status, the player must pay the 2 IPU's to go from level 1 damage to in effect level 0 damage. (Example: If a player has sustained level 3 damage in the food Industry, it would require 6 IPU's to fully repair this industry.) Players should consider when repairing damage, that some units that they may wish to purchase in the purchase units phase may require repair in more than one industry in order to build these units. For example, a player wishes to purchase 4 Armor (Tank) units in the purchase units phase of their turn, and has sustained damage level 5 in the ball bearings industry, as well as damage level 4 in the oil / gas industry. This player would have to repair BOTH industries to damage level 1 to build the 4 units. The cost for this repair would be a total of 14 IPU's. (8 IPU's to repair the ball bearing industry from damage level 5 to damage level 1, and 6 IPU's to repair the oil / gas industry from damage level 4 to damage level 1).

Players also need to take into account that damage on the EBR chart in a particular industry that effects multiple unit types hinders the production of all of those unit types as a whole. For example, if a player has sustained level 4 damage in the shipyards industry, then the player cannot build more than 1 total sea unit anywhere in the world. The effects of the EBR chart reflect ALL of the players ability to build units anywhere, not just on a factory by factory basis.

There are 2 special categories on the EBR chart that do not effect the production of units. These are the Munitions and Command categories. Damage in these areas effect the dice rolls when a player either attacks other units on their turn, or defends against other units on other players' turns. If a player for example, has level 3 damage in the Munitions category, then anytime the player attacks another players units anywhere in the world, he/she must add 2 to any attack die roll they make. Damage in these 2 areas can severely cripple a players' chance of surviving a battle.

NOTE: Any damaged multiple hit sea units that have successfully met the conditions in section 3.8 of the players previous turn for repairing the unit free of charge are considered fully repaired at this time.

Section 3.4 - Purchase New Units.

In this Phase of a players' turn they must purchase all REAL new units. (Imaginary units such as escort fighters for EBR attacks and Sea Search planes are purchased later.) Players must consult the Chart in Appendix G - Player Unit reference sheet for the IPU cost of each unit purchased.

3.4.1 - Purchase New Units.

Players Pick and choose which new units they will purchase for this turn. These units are placed in a holding area to be placed on the board during the Place Units Phase.

3.4.2 - Place Spy Units.

If the player purchased a Spy Unit in the section above, It must be placed on the game board at this time. If the Spy Unit is placed in an opposing Major Faction or Neutral Country / Minor Power land zone containing Special Forces Units, it will be subject to the find and kill Spy Units portion of the Combat phase of the turn. It is NOT necessary to declare war on an opposing major faction to place a Spy unit in one of their land zones, however, the Spy cannot conduct any actual missions without a declaration of war.

3.4.3 - Place Industrial Factory Economic Upgrade Chips.

If the player purchased any Industrial Factory Economic Upgrade Chips in section 3.4.1 above, these chips are placed under the appropriate factories at this time. The effect of these Economic Upgrade Chips is IMMEDIATE for all purposes during this turn.

3.4.4 - Upgrade Limited Production Factory to Unlimited Production Factory.

If the player purchased the upgrade of a limited production factory to an unlimited production factory unit in section 3.4.1 above, the swap-out for these units is made at this time. The new unlimited production factory retains any economic upgrade chips that have been purchased for it. The effect of this upgrade are IMMEDIATE for all purposes during this turn.

Section 3.5 - Combat Movement.

Combat movement phase is the point in a player's turn where any unit that is going to take place in either a battle or a diplomatic attempt to take over a country moves into position. The types of movement that take place in this phase are:

3.5.1 - Land Movement

Land based units that move in the phase of the turn must end their movement in an enemy land zone where they can do one of the following.

1. Attack enemy units located in the land zone.
2. Be part of a Diplomatic attempt to take over a land zone.
3. Conquer the new enemy land zone because it is vacant of units.

3.5.2 - Air Movement.

Air based units that move in this phase must complete one of the following tasks.

1. Move to an enemy land zone to attack enemy units.
2. Move to an enemy land zone to be part of a Diplomatic attempt to take over a land zone.
3. Move to an enemy controlled sea zone to search for and attack enemy units.
4. Transport land based units to an enemy land zone and drop them off to complete 1 of the 3 land based missions listed above.
5. Move to an enemy land zone containing an Industrial Factory to conduct an Economic Bombing Raid (Bomber Units only). At this time, the player must decide whether or not to purchase Escort Fighter units. See Appendix C - EBR Rules.

3.5.3 - Sea Movement.

Sea based units that move in this phase must complete one of the following tasks.

1. Move to an enemy controlled sea zone to search for and attack enemy units.
2. Move to a friendly sea zone to be part of an amphibious assault to take over an adjacent land zone (Shore bombardment capable units only)
3. Move to a friendly sea zone to be part of a Diplomatic attempt to take over an adjacent land zone (Shore bombardment capable units only)
4. Transport land based units to an enemy land zone and drop them off to complete 1 of the 3 land based missions listed above.

3.5.4 - Special Unit Movement.

Special based units that move in this phase must complete one of the following tasks.

1. Spy units move or are transported to an enemy land zone to conduct a mission.
2. Atomic bomb units are transported to an enemy land zone or an enemy controlled sea zone to be deployed.

For all of the above situations, please refer to the detailed description of each unit type in Section 2.0 of this manual for capabilities and limitations of that unit.

Section 3.6 - Combat.

In this section of the players' turn, all spy missions, diplomatic missions, and combat to destroy enemy or neutral players actually take place. All of the sections below must occur in order.

3.6.1 - SPY MISSIONS.

3.6.1.1 - Declare Spy Missions.

The player must declare if any spy unit missions are to occur. The player must declare what type of spy mission each spy is going to attempt.

3.6.1.2 - Spy detection and elimination.

If the spy unit is in a land zone containing enemy special forces units, and the player has declared that spy will attempt to conduct a mission, then all the special forces units in that land zone may attempt to eliminate the spy. This is a 2 step procedure. The first step is to locate the spy unit. If the unit is located in an Axis regime or Russian owned land zone, then the owning player of that land zone rolls one 6-die per special forces unit to determine how many special forces in that zone have spotted any spy units in that zone conducting a mission. On a die roll of 1 or 2, the spy unit(s) have been found. If the unit is located in an Allies regime owned land zone, then the owning player of that land zone rolls one 8-die per special forces unit to determine how many special forces in that zone have spotted any a spy unit in that zone conducting a mission. On a die roll of 1 or 2, the spy unit(s) have been found. The second part of this procedure is the execution of the spy unit(s). Any nation (except the USA) must now roll a second die (this time all roll one 6-sided) for each special forces unit that found a spy unit on the first roll. On a die roll of 1-3, the special forces unit has successfully killed a spy unit. Any spy unit found by the USA is automatically considered captured and imprisoned, and is removed from the board. All executed spies are removed from the game. All spies who are captured and not executed become the property of capturing nation for their next turn. They start from the zone they are currently placed in, and move from there normally.

3.6.1.3 - Conduct spy unit missions. (Except EBR assist).

Any spy unit that was not eliminated in the section 3.6.1.2 may now conduct the mission it declared in section 3.6.1.1 except EBR assist missions. Please see the detailed descriptions page for spy units on how to conduct each specific mission.

3.6.2 - RADAR ALERT AND FIGHTER DEFENSE.

If any aircraft flew directly over or within a one zone range radius of a radar unit or aircraft carrier, that unit may now roll for radar detection of enemy units. Each radar unit and aircraft carrier must roll separately. A roll of 1 or 2 on a 6-sided die indicates that the radar unit detected the enemy aircraft. If this occurs, then the enemy player may call up his fighter units to help defend units on other zones, but only if the fighter unit meets the following criteria.

1. The land or sea zone that the fighter unit is in must not be under attack by any units.
2. The land zone the fighter unit wishes to help defend must be within a range of 1 zone from its current location.
3. The land zone the fighter unit wishes to defend must be within a range of 1 zone from the radar unit or aircraft carrier unit that detected the enemy aircraft.

Section 3.6 - Combat. (Cond.)

3.6.3 - LAUNCH ROCKET LAUNCHER ATTACKS.

If the player has any rocket launcher units, the player may fire them according to the rules specified in the detailed description section for this unit.

3.6.4 - DIPLOMACY ROLL.

If the player has met all the conditions set out in Appendix E, he/she may make their one Diplomacy roll at this time. If the result fails to get the country to join the faction, continue to the next section here.

3.6.5 - COMBAT ROUNDS.

This section is completed for each zone on the map board where combat is to occur. The player needs to conduct these battles in the following order.

1. Any combat in a zone where an Atomic Bomb unit is to be deployed.
2. Any combat in a zone where an EBR attack is to be attempted.
3. Any combat that involves the takeover of an Industrial factory.
4. Combat where a failed diplomacy roll is involved.
5. All other combat zones.

3.6.5.1 - SEA ZONE DETECTION AND/OR WITHDRAWAL.

Please see the rules in Appendix F to complete this section.

3.6.5.2 - SPECIAL ROUND 0 FAILED DIPLOMACY ATTACK.

Please see the rules in APPENDIX G to complete this section.

3.6.5.3 - SHORE BOMBARDMENT ATTACKS.

Units that fire a shore bombardment type of attack fire at this time. Any casualties that occur on the side of the defender are immediately removed from the board. These units do not get to return fire.

3.6.5.4 - AA/AA GUN AND COASTAL GUN ATTACKS.

All AA/AA guns and Coastal gun units fire at this time. A coastal gun may shoot as an AA/AA gun first, then as a coastal gun as well. Any casualties that occur on the side of the attacker are immediately removed from the board. They do not get to continue attacking.

3.6.5.5 - DEPLOY ATOMIC BOMB.

If the combat in this zone involves deploying an Atomic Bomb unit, it is deployed at this time. Please see the detailed rules for this unit for results.

3.6.5.6 - EBR ATTACKS (Spy unit EBR assist mission).

If the combat in this zone involves this type of attack, it is completed at this time. Please see Appendix D for specific rules on how to complete this action.

3.6.5.7 - CALL UP RESERVE INFANTRY UNITS.

This section only applies if this is the second or higher round of combat in this particular zone.

Please see the detailed description rules for Reserve Infantry units to perform this action.

3.6.5.8 - MOVE UNITS TO THE BATTLE REFERENCE BOARD.

All units still involved in this battle at this time are moved to the battle reference board and placed in the appropriate box for the unit type for both the attacker and the defender.

Section 3.6 - Combat. (Cond.)

3.6.5.9 - ATTACKING UNITS FIRE.

Any units on the attacker's side of the battle reference card that can fire during this combat round may fire at this time. (Please see detailed description for each unit type, as some attacking units cannot fire during the first round of an amphibious assault attack.) For each attack die rolled, the attacker must make sure that he/she is rolling the correct type of die. (Please see the detailed description page for each type of unit rolling an attack die). Each time the attacker rolls a die and scores a hit on a defenders unit, the defender must either pick one of his/her units and place it in the casualty box, or place a black chip under a unit that can withstand multiple hits. (Please see exceptions to this rule for when either the attacking unit is a submarine, and/or the defender picks a destroyer unit as a casualty. These exceptions are located in the detailed descriptions for submarine and destroyer units.)

3.6.5.10 - DEFENDING UNITS DECLARATION OF RETREAT.

At this time, some of the defenders units may decide to run rather than fight. Not all units are capable of this action. The following units may retreat according to these guidelines.

1. All air units. - Any air unit may retreat to an adjacent zone on the board if all the following conditions apply.
 - A. The zone being retreated to is not or has not come under attack during the current attacking players turn.
 - B. The zone being retreated to would not result in any type of combat situation.
 - C. The air unit cannot carry any other units in its retreat.
 - D. The air unit has not been picked as a casualty.
2. Submarines and Battleships. These units may retreat to an adjacent sea zone if all of the following conditions apply.
 - A. The zone being retreated to is not or has not come under attack during the current attacking players turn.
 - B. The zone being retreated to would not result in any type of combat situation.
 - C. The Submarine or Battleship unit cannot carry any other units in its retreat.
 - D. The Submarine or Battleship unit has not received a hit or been picked as a casualty due to combat attacks in the current combat zone.

3.6.5.11 - DEFENDING UNITS FIRE.

Any units on the defender's side of the battle reference card that can fire during this combat round may fire at this time. (Please see exceptions to this rule for when either the attacking unit is a submarine, and/or the defender picks a destroyer unit as a casualty. These exceptions are located in the detailed descriptions for submarine and destroyer units.) For each defense die rolled, the defender must make sure that he/she is rolling the correct type of die. (Please see the detailed description page for each type of unit rolling a defense die). Each time the defender rolls a die and scores a hit on an attackers' unit, the attacker must either pick one of his/her units and place it in the casualty box, or place a black chip under a unit that can withstand multiple hits. (Please note that the defender also gets to make appropriate defense rolls for all units currently located in the casualty box.)

3.6.5.12 - REMOVAL OF CASUALTIES.

At this time, all of the attackers and defenders units that are located in the casualty box on the battle reference card are removed from play and placed back into the appropriate players unit tray.

Section 3.6 - Combat. (Cond.)

3.6.5.12 - ATTACKING UNITS DECLARATION OF RETREAT.

At this time, some or all of the attackers units may decide to run rather than fight. Not all units are capable of this action. The following units may retreat according to these guidelines.

1. All land units. - Any land unit may retreat to an adjacent zone on the board if all the following conditions apply.
 - A. The zone being retreated to is not or has not come under attack during the current attacking players turn.
 - B. The zone being retreated to would not result in any type of combat situation.
 - C. The land unit cannot carry any other units in its retreat.
 - D. The land unit did not arrive in the current combat zone by being transported by a sea unit.
1. All air units. - Any air unit may retreat to an adjacent zone on the board if all the following conditions apply.
 - A. The zone being retreated to is not or has not come under attack during the current attacking players turn.
 - B. The zone being retreated to would not result in any type of combat situation.
 - C. The air unit cannot carry any other units in its retreat.
2. All sea units. These units may retreat to an adjacent sea zone if all of the following conditions apply.
 - A. The zone being retreated to is not or has not come under attack during the current attacking players turn.
 - B. The zone being retreated to would not result in any type of combat situation.
 - C. The Sea unit cannot carry any other units in its retreat.

3.6.5.13 - CONTINUE OR END BATTLE IN THIS ZONE.

Battle for the current zone must continue to the next combat round unless one of the following conditions are met;

1. All of the defenders units in the current combat zone have either been eliminated or retreated to an adjacent zone following the rules for defender retreat.
2. All of the attackers units in the current combat zone have either been eliminated or retreated to an adjacent zone following the rules for attacker retreat.

Unless one of the above 2 conditions have been met, players repeat sections 3.6.5.7 through 3.6.5.12 for this combat zone as many times as it takes until 1 condition is completed.

Section 3.7 - Non-Combat Movement.

Non-Combat movement phase is the point in a player's turn where any unit that did not take part in either a battle or a diplomatic attempt to take over a country may move into a more strategic position. Also, Air units that did take part in a battle or a diplomatic attempt to take over a country must find a friendly landing zone to return to. Any unit that decided to or was forced to retreat from a battle may not move during this phase. The types of movement that take place in this phase are:

3.7.1 - Land Movement

1. Land based units may move from one friendly land zone to another friendly land zone.
2. APC's may transport infantry units or move from one friendly land zone to another friendly land zone.

3.7.2 - Air Movement.

Air based units that move in this phase must complete one of the following tasks.

1. Move to a friendly land zone or a friendly Aircraft Carrier Unit in a friendly sea zone.
2. Transport infantry units from one friendly land zone to another friendly land zone. (In this phase, the units do not have to start in the same location.)

3.7.3 - Sea Movement.

Sea based units that move in this phase must complete one of the following tasks.

1. Move to a different friendly sea zone.
2. Transport land based units from friendly land zone(s) adjacent to friendly sea zone(s) to a friendly land zone adjacent to a friendly sea zone.
3. Transport land based units from friendly land zone(s) adjacent to friendly sea zone(s) to a friendly sea zone and keep the unit(s) aboard ship until next turn.

3.7.4 - Special Unit Movement.

Special based units that move in this phase must complete one of the following tasks.

1. Spy units move or are transported from one friendly land zone to a different friendly land zone or may stay aboard ship until next turn if transported by sea.
2. AA/AA gun units move or are transported from one friendly land zone to a different friendly land zone or may stay aboard ship until next turn when transported by sea.
3. Coastal gun units move from one friendly land zone to a different friendly land zone at a movement cost of 1 IPU which the player must pay at this time.
4. Rocket Launcher units move or are transported from one friendly land zone to a different friendly land zone or may stay aboard ship until next turn when transported by sea.
5. Limited and unlimited production Industrial Factory Units may move from one friendly land zone to a different friendly land zone at a cost determined by the type of factory and how many Economic Upgrade chips are under it which the player must pay at this time.
6. Atomic bomb units are transported from a friendly land zone containing an Industrial Factory unit to a different friendly land zone containing an Industrial Factory unit or may remain aboard a sea unit in a friendly sea zone if transported by sea.

For all of the above situations, please refer to the detailed description of each unit type in Section 2.0 of this manual for capabilities and limitations of that unit.

Section 3.8 - Repair of Multiple Hit Units.

In this phase of a player's turn, if the player has any technological advances that allow a unit to take 2 or 3 hits to destroy, it is possible to repair that unit. The player has to satisfy both conditions below to make the repairs.

1. The damaged unit has to be in a sea zone adjacent to a friendly land zone containing an Industrial Factory Unit.
2. The player may pay the following costs per damage point to repair the unit back to full strength.
 - A) Destroyers and Submarines cost 2 IPU's to repair.
 - B) Cruisers cost 3 IPU's to repair.
 - C) Aircraft Carriers and Battleships cost 4 IPU's to repair.

OR

2. If the damaged unit can remain in the zone it is located in until the beginning of the player's turn in the next game round, without moving / being forced to retreat / or being attacked or bombed, it is considered fully repaired free of charge at that time.

Section 3.9 - Industrial factory take over and surrender of IPU's

If a player has captured any land zones containing a limited production or an unlimited production Industrial Factory unit, the player who previously owned the factory must surrender 2 times the IPU value of the land zone plus 1 IPU for each Economic Upgrade Chip located under the Factory unit. This exchange represents the captured raw materials located at the factory unit for production in the losing player's next turn. The chart below represents the damage that Industry in that zone took as a result of the battle in that area.

Limited production Industrial Factory.

Either lose 1 Economic Upgrade Chip or be destroyed if no chips exist.

Unlimited production Industrial Factory.

Either lose 2 Economic Upgrade Chips or be reduced to a limited production Industrial factory unit if only 1 chip or no chips exist. If the factory is reduced because it has only 1 chip, it retains the 1 chip it currently possesses. If an unlimited production factory possesses more than 2 economic upgrade chips, the player must choose to lose 2 chips rather than reduce the factory.

Section 3.10 - Capital Factory Takeover of a country.

The rules contained in this section cover what occurs when a player has conquered a land zone containing either a capitol industrial factory unit, or the land zone belongs to one of the 4 minor power countries. (Spain, Portugal, The Netherlands, or Belgium.) The rules may be different based on which capitol factory zone has been conquered.

3.10.1 - Takeover of Italy.

If a player conquers Italy, then the following occurs;

1. All Industrial factories belong to the Italian player are immediately destroyed.
2. All remaining Italian units on the map board are removed, and replaced with identical German units.
3. Any IPU's that the Italian player possesses, are considered destroyed.
4. The Italian player is considered eliminated from the game.

3.10.2 - Takeover of France.

There are two different situations that can occur when a player conquers France. If the province of Vichy is still in the possession of the French player, then proceed to section 3.10.2.1 If the province of Vichy has also been conquered by another or the same player, then follow the procedures in section 3.10.2.2.

3.10.2.1 - TAKEOVER OF FRANCE WITH VICHY IN FRENCH CONTROL.

1. Remove the French Capitol factory from the board. Destroy any economic upgrade chips that were located under it. Either place the Capitol factory unit in the Vichy province if no factory currently exists there, or replace the current factory with the Capitol factory retaining any economic upgrade chips that exist under the current factory.
2. Roll one 8-sided die for EVERY French unit left on the map board.
 - A. If the die roll is a 1-3, then the unit remains in control of the French player.
 - B. If the die roll is a 4-6, replace the unit with a neutral unit.
 - C. If the die roll is a 7-8, replace the unit with a German unit.
3. If units from 2 or more countries now exist in a zone, complete the following:
 - A. German units must attack the neutral units following the procedures in sections 3.6.3.8 through 3.6.6.12 until 1 side is eliminated, or the German units have retreated. The defending neutral units may not retreat during this combat.
 - B. Whichever side is the victor in section A above must now attack the French units in the zone following the procedures in sections 3.6.6.8 through 3.6.6.12 until 1 side has been eliminated, or the French units has retreated. The attacking neutral units may not retreat during this combat.
 - C. If after completing sections A and B above, any German units exist in a zone containing other allied regime units, these units must be either retreated to an adjacent friendly zone or destroyed.
 - D. If after completing sections A and B above, any neutral units exist in a zone containing other allied regime units, they are immediately destroyed.
4. All former French land zones now containing just German units now become the property of Germany.
5. All former French land zones now containing just neutral units become the equivalent of a neutral country except that they may not be the subject of a diplomacy roll ever in the future.
6. All former French land zones now containing only French or another Allied regime's units remain under French control.

Section 3.10 - Capital Factory Takeover of a country. (cond.)

3.10.2.2 - TAKEOVER OF FRANCE WHEN VICHY HAS ALSO BE CONQUERED.

1. Remove the French Capitol factory from the board and destroy all economic upgrade chips located under it.
2. The French player must surrender all of its IPU's to the player who conquered France up to a maximum of 15 IPU's. The remaining IPU's are destroyed.
3. Roll one 8-sided die for EVERY French unit left on the map board.
 - A. If the die roll is a 1-5, replace the unit with a neutral unit.
 - B. If the die roll is a 6-8, replace the unit with a German unit.
3. If units from 2 or more countries now exist in a zone, complete the following:
 - A. German units must attack the neutral units following the procedures in sections 3.6.3.8 through 3.6.6.12 until 1 side is eliminated, or the German units have retreated. The defending neutral units may not retreat during this combat.
 - B. If after completing section A above, any German units exist in a zone containing other allied regime units, these units must be either retreated to an adjacent friendly zone or destroyed.
 - C. If after completing sections A above, any neutral units exist in a zone containing other allied regime units, they are immediately destroyed.
4. All former French land zones now containing just German units now become the property of Germany.
5. All former French land zones now containing just neutral units or no units become the equivalent of a neutral country except that they may not be the subject of a diplomacy roll ever in the future.
6. All former French land zones now containing other Allied regime's units become the property the player with the most land based units in the zone. If the case of a tie, the players involved each roll a 6-sided die. High roll gets control of the zone.
7. At this point, the French player is eliminated from the game.

3.10.3 - Takeover of a minor power country.

If a player conquers or gets the capitol zone of a minor power nation to join his/her faction through a diplomatic roll, the fate of the colony nations under that minor power that have not been conquered or joined a players' faction through a diplomacy roll must be decided. This is done by a simple die roll. The player who captured the minor power capitol nation rolls one 8-sided die for each colony to be decided. The results are as follows:

Die roll of 1-3	Colony country declares independence. For the rest of the game, is it treated like any other neutral country for all purposes.
Die roll of 4-6	Colony country sides with the nation who captured the capitol nation. The land zone and all of the units in it become the property of that player. They are replaced with identical units of that players color.
Die roll of 7-8	Colony country sides with a different nation. All other active players in the game roll one 6-sided die. High die roll gets control of that nation and all the units in it. They are replaced with identical units of that nation.

Section 3.10 - Capital Factory Takeover of a country. (cond.)

3.10.4 - Takeover of Berlin, England, Japan, Kiangsi, Eastern USA, or Moscow.

When one of these capitols are taken by another player, as opposed to the others, the procedures to be followed are quite different.

1. Remove the capitol factory from the board. Destroy any economic upgrade chips located under the capitol factory.
2. The player whose capitol has been taken must pay the conquering player 10 IPU's plus 1 IPU for every remaining economic upgrade chip they have left on the entire map board.
3. The player must immediately pay to rebuild their capitol factory on a different land zone that currently own under the following guidelines.
 - A. The land zone must one of their original starting land zones.
 - B. If the land zone has no industrial factory currently located on it, the cost to rebuild the capitol factory is 20 IPU's.
 - C. If the land zone has a limited production factory on it, the cost to swap this factory out for the capitol factory is 15 IPU's. Any economic upgrade chips under the current factory are retained.
 - D. If the land zone has an unlimited production factory on it, the cost to swap this factory out for the capitol factory is 10 IPU's. Any economic upgrade chips under the current factory are retained.

If the player cannot afford to immediately rebuild their capitol factory, or has no place to rebuild their capitol factory, they are considered eliminated from the game.

(See section 3.10.5 below.)

4. Any player who has relocated their capitol factory is considered to be in a forced relocation status for victory conditions. (See section 4.0 - Victory conditions for details.)
5. Any player who has relocated their capitol factory must suffer a 5 IPU loss during the collect IPU's phase of their turn.

3.10.5 - Elimination of Germany, The U.K., Japan, China, The USA, or Russia from the game.

Whenever one of the above named countries has its original capitol land zone conquered by another player, and it cannot afford to relocate or has no where to relocate its capitol factory, it is considered eliminated from the game. This is also true if the land zone where the capitol factory was relocated to is conquered by another player. When one of these players are eliminated from the game, the following occurs;

1. The player surrenders all current IPU's back to the bank.
2. All of the players factories on the board, along with their economic upgrade chips are destroyed.
3. The remainder of the players units cannot move for the rest of the game, not even to retreat.
4. The sole purpose for the players' units remaining on the board is to defend their current location.
5. The players units remain loyal to the regime they belonged to for purposes of other players movement.
6. In the event of a battle, the eliminated players units must be the first casualties removed.

Section 3.10 - Capital Factory Takeover of a country. (cond.)

3.10.6 - The capture of Vichy after France has fallen.

If the French player loses the province of Vichy after France has been conquered by another player, and the capitol factory has been relocated to Vichy, the France is considered eliminated from the game and must follow the same procedures contained in section 3.10.5.

3.10.7 - Recapture of an original capitol factory land zone.

With the exception of Italy, whenever a player, or one of its regime allies, recaptures the original land zone that the player's capitol factory was located in, the following occurs.

1. The player's capitol factory is reinstated back to its original location, however, any economic upgrade chips located under the factory are destroyed. No cost is involved to complete this move.
2. For victory conditions, the player is no longer in a forced relocation status. (Please see section 4.0 - Victory conditions for details.)
3. The player is considered to be fully restored and no longer suffers the 5 IPU loss during its collect IPU's phase of its turn.
4. The player is again subject to all conditions and must follow the same procedures as before should its capitol factory be conquered a second time.

Section 3.11 - Placement of Purchased units.

During this phase of a players' turn, the player places the rest of the units purchased during Section 3.4 - Purchase Units Phase on the game board that have not already been previously placed during other phases of the players' turn. Units must be placed in the order shown below.

3.11.1 - Destroy Factory Units.

A player may at this time, destroy any limited or unlimited production factories they own on the board. The player must pay the appropriate amount of IPU's to perform this action at this time.

3.11.2 - Place Land based Units.

The player places all of his/her land based units in a land zone that was in the players control at the very beginning of his/her turn. Units may not be placed in land zones that were acquired during this turn unless the land zone joined the players faction through a diplomacy roll. The player must take into account the building limitations of each zone and unit type when placing his/her units.

3.11.3 - Place Air based Units.

The player places all of his/her air based units in a land zone that was in the players control at the very beginning of his/her turn. Units may not be placed in land zones that were acquired during this turn unless the land zone joined the players faction through a diplomacy roll. The player must take into account the building limitations of each zone and unit type when placing his/her units.

3.11.4 - Place Sea based Units.

The player places all of his/her sea based units in a sea zone adjacent to a land zone that was in the players control at the very beginning of his/her turn. Units may not be placed in sea zones that contain sea units from an opposing country or neutral country. Units may not be placed in a sea zone adjacent to a land zone that was acquired during this turn unless the land zone joined the players faction through a diplomacy roll or the sea zone is adjacent to a different land zone that was controlled by the player at the beginning of his/her turn. The player must take into account the building limitations of each zone and unit type when placing his/her units.

3.11.5 - Place Special Units.

The player places all of his/her special units in a land zone that was in the players control at the very beginning of his/her turn. Units may not be placed in land zones that were acquired during this turn unless the land zone joined the players faction through a diplomacy roll. The player must take into account the building limitations of each zone and unit type when placing his/her units. All new limited production factory units are placed last.

Section 3.12 - Collect IPU's and end turn.

This is the final phase in a players' turn. At this point, the player counts up the IPU value of all of the land zones he/she controls. The player then counts up all the economic upgrade chips located under all of the industrial factories that the player owns. The total of these two numbers is the amount of IPU's that the player collects for use in their next turn in the next game round.

Section 4.0 - Victory Conditions.

At the end of each game round, it must be determined if there is a winner and the game is over. There are 2 different ways to determine this. Victory can be claimed by a team of players or by an individual player within a team. Each player or team of players victory conditions is different. All of the different victory scenarios are listed below.

1. Axis team victory conditions.

A) When Russia joins the Axis Regime:

1. Either completely take over or force the relocation of any 3 Allied Capitol Factories.

B) When Russia joins the Allies regime: (must complete both parts separately).

1. Either completely take over or the forced relocation of Moscow.

2. Either Completely take over or the forced relocation of any 2 Allied Capitol Factories

C) While Russia is still a Neutral player or Russia is forced to be at war with everyone:

3. Either Completely take over or the forced relocation of any 3 enemy Capitol Factories.

Axis Individual Victory conditions within the regime:

Each country within the Axis regime counts up its current IPU level and divides it by that countries' original IPU economy at the beginning of the game. The player with the highest number wins.

2. Allies team victory conditions.

A) When Russia joins the Allies Regime:

1. Either completely take over or force the relocation of all 3 Axis Capitol Factories.

B) When Russia joins the Axis regime: (must complete both parts separately).

1. Either completely take over or the forced relocation of Moscow.

2. Either Completely take over or the forced relocation of any 2 Axis Capitol Factories

C) While Russia is still a Neutral player or Russia is forced to be at war with everyone:

3. Either Completely take over or the forced relocation of any 3 enemy Capitol Factories.

Allies Individual Victory conditions within the regime:

Each country within the Allies regime counts up its current IPU level and divides it by that countries' original IPU economy at the beginning of the game. The player with the highest number wins.

3. Russia as a neutral individual victory condition.

If Russia can either completely take over or force the relocation of any 3 Capitol Factories anywhere in the world without joining either regime, it can claim a game victory.

NOTE: The forced relocation of a countries Capitol factory only counts if it is from its ORIGINAL location. If a country either liberates its original capitol factory zone, or a friendly regime player liberates it for them, and the player moves their capitol factory back to its original location, then the country is no longer considered in forced relocation status. If this occurs, the country that forced the relocation can no longer claim that country towards its victory condition.

Appendix A - Initial piece setup locations.

The following section contains charts for each land and sea zone where units exist in the world at the beginning of the game. Please note that units for the Neutral countries and Minor Power nations do not need to be placed on the board at this time. They only come into effect if one of the major faction players decides to attack one of these zones or attempt to take the zone over by means of a diplomacy roll. Nazi sympathizer nation units do not need to be placed on the board at the beginning of the game either, but chances are very good that they will come into effect very early in the game.

To determine how many units go where, consult the graph charts on the following pages. They are divided up in order by each countries land and air units in one chart, followed by a chart for all of that countries sea units.

As there are no specific names for any sea zone on the board, the graphs contain specific descriptions of which sea zone is being indicated by the names of the land zones that surround it. The name specified is detailed enough that only one zone can fit that description. If more than one country name is indicated in the identification of the sea zone, the reference means a sea zone that is adjacent to all of the countries named.

There are over 130 blow up boxes surrounding the main section of the map. These zones are provided to make it easier for all of the pieces to fit on the board. Players should take into consideration all units located in the blow up box for a particular zone as well as those in the main map area when moving their units and conducting attacks on a zone. Please note that there are also blow up boxes surrounding the main map board for some of the smaller sea zones on the map as well. These blow up boxes are also named by using descriptions of the countries that surround them.

When consulting the following charts, players need to place the appropriate number of each type of unit indicated using a combination of units and chips. When all of the units have been placed, the game is ready to begin round 1 with Germany/Italy starting the game.

Players should note that there are 4 areas on the board that a player must either own or have permission from the owning player in order to pass their sea units from one zone to another. They are as follows; Neutral and Minor power countries never give permission and must be taken.

Suez canal Zone	U.K. Player controls this area.
Turkey	Neutral Country.
Panama Canal	USA player controls this area.
Straight of Gibraltar	Control is shared by U.K. In Gibraltar. and by Spain in Spanish Morocco.

These passageways are marked by a small curved line on the map.

ITALY Land Zones

Name of Country / Province.	Regular Infantry	Special Forces Infantry	Reserve Infantry	Armored Personnel Carrier	Armor (Tanks)	Fighter Plane	Transport Plane	Bomber Plane	AAAT Gun	Coastal Gun	Radar Tower	Limited Production Factory	Unlimited Production Factory	Capital Production Factory
Italy (Capital)	5	4	4	1	2	2	1	1	1	X	1	X	X	1
Sicily	2	1	X	X	X	X	X	X	X	X	X	X	X	X
Libya	2	1	X	1	1	1	X	X	X	X	X	X	X	X
Sardinia	2	1	X	X	X	X	X	X	X	X	X	X	X	X
Albania	3	X	X	X	X	X	X	X	X	X	X	X	X	X
Italian Eritria	2	X	X	X	X	X	X	X	X	X	X	X	X	X
Italian East Africa	2	1	X	1	X	X	X	X	X	X	X	X	X	X
Italian Somaliland	1	X	X	X	X	X	X	X	X	X	X	X	X	X

ITALY Sea Zones

Name of Sea Zone	Sea Transport	Destroyer	Submarine	Cruiser	Battleship	Aircraft Carrier	Fighters (on Carriers)
Italy / Sicily	2	1	2	1	X	X	X
Italy / Yugoslavia	1	1	1	X	X	X	X
Italian Somaliland	1	X	1	X	X	X	X

Germany Land Zones

Name of Country / Province.	Regular Infantry	Special Forces Infantry	Reserve Infantry	Armored Personnel Carrier	Armor (Tanks)	Fighter Plane	Transport Plane	Bomber Plane	AAAT Gun	Coastal Gun	Radar Tower	Limited Production Factory	Unlimited Production Factory	Capital Production Factory
Berlin	7	5	5	2	4	2	2	2	1	X	1	X	X	1
Ruhr Valley	5	4	X	2	2	2	2	1	1	X	X	X	1	X
Rhine River Valley	4	3	X	2	2	2	X	X	1	X	X	X	1	X
Bavaria	4	3	X	2	2	2	X	2	1	X	X	X	1	X
Austria	3	3	X	2	2	2	2	X	X	X	1	1	X	X
Sudetenland	2	2	X	X	X	1	X	X	X	X	X	X	X	X
East Prussia	3	2	X	X	X	2	2	X	X	X	X	X	X	X
Nazi Sympathizers														
Czechoslovakia	3	1	X	2	2	X	X	X	X	X	X	X	X	X
Hungary	2	2	X	1	1	X	X	X	X	X	X	X	X	X
Romania	2	2	X	2	1	1	X	X	X	X	X	X	X	X
Bulgaria	3	2	X	1	2	X	1	X	X	X	X	1	X	X
Iran (Persia)	3	2	X	1	1	1	X	X	X	X	X	1	X	X
Lithuania	2	1	X	X	1	X	1	X	X	X	X	X	X	X
Finland	2	1	X	1	1	X	X	X	X	X	X	X	X	X

GERMANY Sea Zones

Name of Sea Zone	Sea Transport	Destroyer	Submarine	Cruiser	Battleship	Aircraft Carrier	Fighters (on Carriers)
Berlin / Denmark	2	3	1	2	1	X	X
Norway / Denmark	X	X	3	X	X	X	X
E. Prussia / Sweeden	2	2	2	1	X	X	X
Ruhr Valley / Netherlands	X	2	3	1	X	X	X
Northwest Norway	X	X	2	X	X	X	X
Northeast Greenland	X	X	X	X	X	X	X
Iceland	X	X	X	X	X	X	X
Azore Islands	X	X	X	X	X	X	X
Cape Verde Islands	X	X	X	X	X	X	X
Uruguay / Argentina	X	X	X	1	X	X	X

FRANCE Land Zones

Name of Country / Province.	Regular Infantry	Special Forces Infantry	Reserve Infantry	Armored Personnel Carrier	Armor (Tanks)	Fighter Plane	Transport Plane	Bomber Plane	AAAT Gun	Coastal Gun	Radar Tower	Limited Production Factory	Unlimited Production Factory	Capital Production Factory
France (Capital)	5	5	5	2	3	2	2	1	1	X	1	X	X	1
Vichy	2	3	X	X	2	1	X	X	X	X	X	1	X	X
Savoy	3	3	X	X	X	X	X	X	X	X	X	X	X	X
Corsica	1	X	X	X	X	X	X	X	X	X	X	X	X	X
French Morocco	2	1	X	X	X	X	X	X	X	X	X	X	X	X
Algeria	3	3	X	1	1	X	X	X	X	X	X	X	X	X
French West Africa	2	2	X	1	1	1	X	X	X	X	X	X	X	X
Fr. Equatorial Africa	2	2	X	X	2	1	X	X	X	X	X	X	X	X
French Cameroon	2	X	X	X	X	X	X	X	X	X	X	X	X	X
Lebanon	1	1	X	X	X	X	X	X	X	X	X	X	X	X
Syria	1	X	X	X	1	X	X	X	X	X	X	X	X	X
French Guinea	1	X	X	X	X	X	X	X	X	X	X	X	X	X
French Togoland	1	X	X	X	X	X	X	X	X	X	X	X	X	X
Fr. Madagascar	1	X	X	X	X	X	X	X	X	X	X	X	X	X
Fr. Somaliland	1	X	X	X	X	X	X	X	X	X	X	X	X	X
Indonesia	1	2	X	X	X	X	1	X	X	X	X	X	X	X
Borneo Celebes	X	3	X	X	X	X	X	X	X	X	X	X	X	X
French Indo-China	1	1	X	X	X	1	X	X	X	X	X	X	X	X
New Fr. Guinea	1	X	X	X	X	X	X	X	X	X	X	X	X	X
New Calidonia Is.	1	X	X	X	X	X	X	X	X	X	X	X	X	X
Fr. Polynesia	1	X	X	X	X	X	X	X	X	X	X	X	X	X

FRANCE Sea Zones

Name of Sea Zone	Sea Transport	Destroyer	Submarine	Cruiser	Battleship	Aircraft Carrier	Fighters (on Carriers)
England / France	1	2	1	2	1	X	X
Western France / Spain	X	X	1	X	X	X	X
Balearic Islands	1	X	1	X	X	X	X
Corsica / Sardinia	1	X	1	X	X	X	X
SW Indonesia	1	1	1	1	X	X	X
French Indo-China	1	1	1	X	X	X	X
Borneo Celebes	1	1	X	X	X	X	X
Fr. Polynesia	X	1	1	X	X	X	X

JAPAN Land Zones

Name of Country / Province.	Regular Infantry	Special Forces Infantry	Reserve Infantry	Armored Personnel Carrier	Armor (Tanks)	Fighter Plane	Transport Plane	Bomber Plane	AAAT Gun	Coastal Gun	Radar Tower	Limited Production Factory	Unlimited Production Factory	Capital Production Factory
Japan (Capital)	3	3	4	X	3	4	3	4	1	X	1	X	X	1
Kyushu Island	2	X	X	X	X	1	X	1	X	X	X	1	X	X
Saporro Island	2	X	X	X	X	X	X	X	X	X	X	X	X	X
Shanghai	3	2	X	1	X	1	X	X	X	X	X	X	X	X
Manchukuo	4	2	X	2	3	2	3	3	1	X	X	X	1	X
Mengjiang	X	2	X	X	1	1	X	X	X	X	X	X	X	X
Chihli	1	1	X	1	3	X	X	X	X	X	X	X	X	X
Jehol	2	2	X	2	2	X	X	X	X	X	X	X	X	X
S. Sakhalin Island	1	X	X	X	X	X	X	X	X	X	X	X	X	X
Korean Peninsula	2	2	X	X	X	X	X	X	X	X	X	X	X	X
Hanan Island	2	1	X	X	X	X	X	X	X	X	X	X	X	X
Taiwan	1	X	X	X	X	X	X	X	X	X	X	X	X	X
Okinawa	2	2	X	X	X	X	X	X	X	X	X	X	X	X
Iwo Jima	1	X	X	X	X	1	1	1	X	X	X	X	X	X
The Palau Islands	2	X	X	X	X	X	X	X	X	X	X	X	X	X
The Caroline Islands	2	X	X	X	X	X	X	X	X	X	X	X	X	X
Tarawa Atoll	1	X	X	X	X	1	X	X	X	X	X	X	X	X
The Solomon Islands	2	X	X	X	X	X	X	X	X	X	X	X	X	X

JAPAN Sea Zones

Name of Sea Zone	Sea Transport	Destroyer	Submarine	Cruiser	Battleship	Aircraft Carrier	Fighters (on Carriers)
Japan	3	8	3	7	4	4	8
Shanghai	1	2	1	X	X	X	X
Taiwan	1	2	1	X	X	X	X
Okinawa	2	2	1	2	X	X	X
Iwo Jima	X	4	1	X	4	2	4
Tarawa Atoll	X	X	1	X	X	X	X
Solomon Islands	X	X	2	X	X	X	X
Samoa Island	X	X	1	X	X	X	X
Caroline Islands	X	X	2	X	X	X	X
The Palau Islands	X	X	3	X	X	X	X
Western Australia	X	X	1	X	X	X	

CHINA Land Zones

Name of Country / Province.	Regular Infantry	Special Forces Infantry	Reserve Infantry	Armored Personnel Carrier	Armor (Tanks)	Fighter Plane	Transport Plane	Bomber Plane	AAAT Gun	Coastal Gun	Radar Tower	Limited Production Factory	Unlimited Production Factory	Capital Production Factory
Kiangsi (Capital)	5	3	5	X	2	2	2	X	1	X	1	X	X	1
Anhwei	3	2	X	X	1	1	X	X	X	X	X	1	X	X
Kiangsu	2	2	X	X	2	X	X	X	X	X	X	X	X	X
Honan	2	1	X	2	2	X	X	X	X	X	X	X	X	X
Chekiang	2	1	X	X	X	X	X	X	X	X	X	X	X	X
Fukien	2	1	X	X	X	X	X	X	X	X	X	X	X	X
Guangdong	2	1	X	X	X	1	X	X	X	X	X	X	X	X
Kwangtung	2	1	X	X	X	1	X	X	X	X	X	X	X	X
Kansu	1	X	X	X	X	X	X	X	X	X	X	X	X	X
Szechwan	1	2	X	1	2	X	X	X	X	X	X	1	X	X
Kwangsi	1	X	X	X	X	X	X	X	X	X	X	X	X	X
Kweichow	1	X	X	X	X	X	X	X	X	X	X	X	X	X
Suiyuan	1	X	X	X	X	X	X	X	X	X	X	X	X	X
Shensi	1	X	X	X	X	X	X	X	X	X	X	X	X	X
Hupei	1	X	X	X	X	X	X	X	X	X	X	X	X	X
Hunan	1	2	X	X	X	X	X	X	X	X	X	X	X	X

RUSSIAN Land Zones

Name of Country / Province.	Regular Infantry	Special Forces Infantry	Reserve Infantry	Armored Personnel Carrier	Armor (Tanks)	Fighter Plane	Transport Plane	Bomber Plane	AAAT Gun	Coastal Gun	Radar Tower	Limited Production Factory	Unlimited Production Factory	Capital Production Factory
Moscow (Capital)	5	5	3	2	3	2	1	2	1	X	1	X	X	1
Leningrad	2	X	X	X	2	1	X	1	1	X	X	X	1	X
Stalingrad	2	X	X	X	2	1	X	1	1	X	X	X	1	X
Estonia	2	1	X	X	X	X	X	X	X	X	X	X	X	X
Latvia	2	1	X	X	X	X	X	X	X	X	X	X	X	X
Belorussian SSR	2	1	X	X	X	X	X	X	X	X	X	X	X	X
Ukrainian SSR	2	1	X	X	X	X	X	X	X	X	X	X	X	X
Karelian SSR	2	2	X	2	2	1	X	1	1	X	X	X	1	X
Bashkir ASSR	2	2	X	2	X	X	X	1	X	X	X	X	X	X
The Caucasus	2	1	X	X	X	X	X	X	X	X	X	X	X	X
Georgian SSR	1	X	X	X	X	X	X	X	X	X	X	X	X	X
Armenia	1	X	X	X	X	X	X	X	X	X	X	X	X	X
Azerbaijan	1	X	X	X	X	X	X	X	X	X	X	X	X	X
Komi ASSR	1	2	X	X	X	X	X	X	X	X	X	X	X	X
Novosibirsk	2	1	X	X	X	X	X	X	X	X	X	X	X	X
Kazakh SSR	2	2	X	1	1	X	1	X	X	X	X	X	X	X
Usbek SSR	1	X	X	X	X	X	X	X	X	X	X	X	X	X
Turkmen SSR	2	1	X	X	X	1	X	X	X	X	X	1	X	X
Kyrgyz SSR	1	X	X	X	X	X	X	X	X	X	X	X	X	X
Tadzhik SSR	1	X	X	X	X	X	X	X	X	X	X	X	X	X
Novaya / Zemiya Is.	1	X	X	X	X	X	X	X	X	X	X	X	X	X

RUSSIAN Land Zones (Page 2)

Name of Country / Province.	Regular Infantry	Special Forces Infantry	Reserve Infantry	Armored Personnel Carrier	Armor (Tanks)	Fighter Plane	Transport Plane	Bomber Plane	AAAT Gun	Coastal Gun	Radar Tower	Limited Production Factory	Unlimited Production Factory	Capital Production Factory
W. Siberian Plain	2	1	X	1	1	X	X	X	X	X	X	X	X	X
C. Siberian Plateau	1	X	X	X	X	X	X	X	X	X	X	X	X	X
Yakut SSR	1	X	X	X	X	X	X	X	X	X	X	X	X	X
Tuvian / Buryat ASSR	2	1	X	X	X	X	X	X	X	X	X	X	X	X
Sikhote-Alin ASSR	2	2	X	X	1	X	X	X	X	X	X	X	X	X
N. Sakhalin Island	1	X	X	X	X	X	X	X	X	X	X	X	X	X
Stanovoy	1	X	X	X	X	1	X	X	X	X	X	X	X	X
Kamchatka Peninsula	2	1	X	X	1	1	1	1	1	X	X	X	X	X
Chersky ASSR	1	X	X	X	X	X	X	X	X	X	X	X	X	X
Kolma / Koryak	2	2	X	X	1	1	X	X	1	X	X	1	X	X

RUSSIAN Sea Zones

Name of Sea Zone	Sea Transport	Destroyer	Submarine	Cruiser	Battleship	Aircraft Carrier	Fighters (on Carriers)
Stanovoy	X	2	2	X	X	X	X
Karelian SSR	4	4	2	X	X	X	X
NE Kolma / Koryak	X	X	2	X	X	X	X
The Black Sea	X	2	2	1	1	X	X
Finland / Sweeden	X	2	2	1	1	X	X
Caspian Sea	2	X	X	X	X	X	X

UNITED STATES Land Zones

Name of Country / Province.	Regular Infantry	Special Forces Infantry	Reserve Infantry	Armored Personnel Carrier	Armor (Tanks)	Fighter Plane	Transport Plane	Bomber Plane	AAAT Gun	Coastal Gun	Radar Tower	Limited Production Factory	Unlimited Production Factory	Capital Production Factory
E. United States (Capital)	7	7	5	2	2	3	2	2	1	X	1	X	X	1
SW United States	4	3	X	1	2	2	2	2	1	X	X	X	1	X
Midwestern United States	4	2	X	2	2	2	2	2	1	X	X	X	1	X
Panama	2	X	X	X	X	X	X	X	X	X	X	X	X	X
Puerto Rico	1	X	X	X	X	1	X	X	X	X	X	X	X	X
SW United States	4	3	X	3	2	2	1	2	1	X	1	X	1	X
NW United States	3	2	X	3	2	2	1	2	1	X	X	X	1	X
Alaska	2	1	X	X	X	1	X	X	X	X	X	X	X	X
Hawaiian Islands	3	2	X	1	1	3	2	2	1	X	X	X	X	X
Midway Island	1	1	X	X	X	1	1	X	X	X	X	X	X	X
Wake Island	1	2	X	X	1	1	X	1	X	X	X	X	X	X
Line Island	1	X	X	X	X	X	X	X	X	X	X	X	X	X
Johnston Island	1	X	X	X	X	X	X	X	X	X	X	X	X	X
Attu Island	1	X	X	X	X	X	X	X	X	X	X	X	X	X
US OCCUPIED ZONES														
Cuban Islands	2	X	X	X	X	1	1	X	X	X	X	X	X	X
Guam	2	X	X	X	1	1	X	X	X	X	X	X	X	X
Philippine Islands	2	2	X	X	1	2	X	1	1	X	X	1	X	X
Chagos Island	2	1	X	X	X	1	X	X	X	X	X	X	X	X

UNITED STATES Sea Zones

Name of Country / Province / Sea Zone	Sea Transport	Destroyer	Submarine	Cruiser	Battleship	Aircraft Carrier	Fighters (on Carriers)
Eastern United States	X	6	6	X	1	1	2
Cuban Is. / SE United States	4	X	3	1	X	X	X
Northern Panama	X	X	1	X	X	X	X
Southern Panama	2	2	1	1	X	X	X
Southern United States	X	2	1	1	X	X	X
Southwestern United States	3	3	1	3	1	2	4
Southeast Alaska	X	3	2	X	X	X	X
Southwest Alaska	X	X	2	X	X	X	X
Northern Alaska	X	X	2	X	X	X	X
Hawaiian Islands	3	5	2	2	5	X	X
Midway Island	X	X	1	X	X	X	X
Wake Island	X	X	1	X	X	X	X
Line Island	X	X	1	X	X	X	X
US Occupied Sea Zones							
Guam	1	1	X	X	X	X	X
The Philippine Islands	2	2	X	X	X	X	X
Chagos Island	1	1	X	X	X	X	X

UNITED KINGDOM Land Zones

Name of Country / Province / Sea Zone	Regular Infantry	Special Forces Infantry	Reserve Infantry	Armored Personnel Carrier	Armor (Tanks)	Fighter Plane	Transport Plane	Bomber Plane	AA/AT Gun	Coastal Gun	Radar Tower	Limited Production Factory	Unlimited Production Factory	Capital Production Factory
England (Capital)	6	4	3	X	3	3	2	4	1	X	1	X	X	1
Scotland	4	3	X	X	2	2	2	X	1	X	X	X	1	X
N. Ireland	1	X	X	X	X	X	X	X	X	X	X	X	X	X
Gibraltar	1	1	X	X	X	X	X	X	1	X	X	X	X	X
Malta	X	2	X	X	X	X	X	X	X	X	X	X	X	X
Cyprus	X	1	X	X	X	X	X	X	X	X	X	X	X	X
Manitoba	1	X	X	X	X	X	X	X	X	X	X	X	X	X
Ontario	1	X	X	X	1	1	X	X	X	X	X	X	X	X
Quebec	1	X	X	1	1	X	X	X	X	X	1	1	X	X
British Guyana	1	X	X	X	X	X	X	X	X	X	X	X	X	X
Falkland Islands	1	X	X	X	X	X	X	X	X	X	X	X	X	X
Anglo-Egyptian Sudan	2	1	X	1	1	X	X	X	X	X	X	X	X	X
Uganda	X	1	X	X	X	X	X	X	X	X	X	X	X	X
Kenya	X	1	X	X	X	X	X	X	X	X	X	X	X	X
Br. Somaliland	1	X	X	X	X	X	X	X	X	X	X	X	X	X
Tanganyika	1	X	X	X	X	X	X	X	X	X	X	X	X	X
N. Rhodesia	1	X	X	X	X	X	X	X	X	X	X	X	X	X
S. Rhodesia	X	1	X	X	X	X	X	X	X	X	X	X	X	X
Bechuanaland	1	X	X	1	X	X	X	X	X	X	X	X	X	X
Vanuatu	1	X	X	X	X	X	X	X	X	X	X	X	X	X
Fiji	X	1	X	X	X	X	X	X	X	X	X	X	X	X
Pitcairn Islands	2	X	X	X	X	X	X	X	X	X	X	X	X	X

UNITED KINGDOM Land Zones (Page 2)

Name of Country / Province / Sea Zone	Regular Infantry	Special Forces Infantry	Reserve Infantry	Armored Personnel Carrier	Armor (Tanks)	Fighter Plane	Transport Plane	Bomber Plane	AA/AT Gun	Coastal Gun	Radar Tower	Limited Production Factory	Unlimited Production Factory	Capital Production Factory
Suez Canal Zone	1	X	X	X	1	X	X	X	X	X	X	X	X	X
Palestine	1	X	X	X	1	X	X	X	X	X	X	X	X	X
Jordan	2	X	X	X	X	1	X	X	X	X	X	X	X	X
Kuwait	2	X	X	X	X	X	X	X	X	X	X	X	X	X
The Trucial States	X	2	X	X	X	X	X	X	X	X	X	X	X	X
Br. Somaliland	X	2	X	X	X	X	X	X	X	X	X	X	X	X
Aden Protectorate	1	X	X	X	X	X	X	X	X	X	X	X	X	X
Pakistan	1	1	X	X	X	X	X	X	X	X	X	X	X	X
India	3	3	X	X	X	X	X	X	1	X	X	1	X	X
NE India	1	X	X	X	X	X	X	X	X	X	X	X	X	X
Bhutan	1	X	X	X	X	X	X	X	X	X	X	X	X	X
Bengal	1	X	X	X	X	X	X	X	X	X	X	X	X	X
East India	X	1	X	X	X	X	X	X	X	X	X	X	X	X
Burma	1	X	X	X	1	1	X	X	X	X	X	X	X	X
Br. Malaya	X	1	X	X	X	X	X	X	X	X	X	X	X	X
Ceylon	1	X	X	X	X	X	X	X	X	X	X	X	X	X
Seychelles Islands	X	1	X	X	X	X	X	X	X	X	X	X	X	X
Western Australia	2	2	X	X	2	X	X	X	X	X	X	X	X	X
South Australia	1	X	X	X	X	X	X	X	X	X	X	X	X	X
Queensland	2	X	X	X	X	X	X	X	X	X	X	X	X	X
New South Wales	2	2	X	X	2	1	X	X	1	X	X	1	X	X
Victoria	2	X	X	X	X	X	X	X	X	X	X	X	X	X

UNITED KINGDOM Land Zones (Page 3)

Name of Country / Province / Sea Zone	Regular Infantry	Special Forces Infantry	Reserve Infantry	Armored Personnel Carrier	Armor (Tanks)	Fighter Plane	Transport Plane	Bomber Plane	AA/AT Gun	Coastal Gun	Radar Tower	Limited Production Factory	Unlimited Production Factory	Capital Production Factory
Basutoland	1	X	X	X	X	X	X	X	X	X	X	X	X	X
Tasmania Islands	1	X	X	X	X	X	X	X	X	X	X	X	X	X
New Zealand	2	X	X	X	1	X	X	X	X	X	X	X	X	X
Gold Coast	1	X	X	X	X	X	X	X	X	X	X	X	X	X
Sierra Leone	X	1	X	X	X	X	X	X	X	X	X	X	X	X
Nigeria	2	X	X	1	X	X	X	X	X	X	X	X	X	X
The Gambia	1	X	X	X	X	X	X	X	X	X	X	X	X	X
Trinidad and Tobago	1	X	X	X	X	X	X	X	X	X	X	X	X	X
Swaziland	X	1	X	X	X	X	X	X	X	X	X	X	X	X
Labrador	1	X	X	X	1	X	X	X	X	X	X	X	X	X
Yukon Territory	1	X	X	X	X	X	X	X	X	X	X	X	X	X

UNITED KINGDOM Sea Zones

Name of Country / Province / Sea Zone	Sea Transport	Destroyer	Submarine	Cruiser	Battleship	Aircraft Carrier	Fighters (on Carriers)
England / Norway	4	3	X	2	2	2	4
Northern Ireland	2	2	X	X	X	X	X
Scotland / Norway	X	X	2	X	X	X	X
No name zone S of Iceland	X	X	1	X	X	X	X
Newfoundland	2	2	1	X	X	X	X
Baffin Is. / Labrador	X	X	1	X	X	X	X
Lesser Antilles Islands	X	X	1	X	X	X	X
Greece / Turkey	X	1	1	X	X	X	X
Kuwait	2	2	1	X	X	X	X
Cyprus	1	X	1	X	X	X	X
Anglo-Egyptian Sudan	X	X	1	X	X	X	X
Pakistan	1	2	1	2	X	X	X
Ceylon	1	2	1	2	X	X	X
Bengal	2	2	2	X	X	X	X
New South Wales	2	3	1	2	X	X	X
Southwest Australia	X	2	1	X	X	X	X
Nigeria	X	2	X	X	X	X	X

Neutral Countries Land Zones

Name of Country	Regular Infantry	Special Forces Infantry	Armor (Tanks)	Fighter Plane	AA/AT Gun	Limited Production Factory	Name of Country	Regular Infantry	Special Forces Infantry	Armor (Tanks)	Fighter Plane	AA/AT Gun	Limited Production Factory
E. Mexico	2	1	X	X	X	X	Turkey	2	1	X	X	X	X
W. Mexico	2	1	X	X	X	X	Tunisia	2	X	X	X	X	X
Guatemala	1	X	X	X	X	X	Crete Island	1	X	X	X	X	X
Honduras	1	X	X	X	X	X	Egypt	1	1	1	X	X	X
Nicaragua	1	X	X	X	X	X	Liberia	1	X	X	X	X	X
Costa Rica	1	X	X	X	X	X	SW Africa	2	1	1	X	X	X
Haiti	1	X	X	X	X	X	Union of S. Africa	2	X	X	X	X	X
Dominican Republic	1	X	X	X	X	X	Sinai Peninsula	1	X	X	X	X	X
Colombia	2	1	X	X	X	X	Yemen	1	X	X	X	X	X
Venezuela	2	1	X	X	X	X	Muscat & Oman	1	X	X	X	X	X
Equador	1	X	X	X	X	X	Iraq	2	2	1	X	X	X
Peru	1	X	X	X	X	X	Saudi Arabia	2	1	1	1	1	1
Brazil	3	3	1	1	1	1	Afghanistan	2	1	2	X	X	X
Bolivia	1	X	X	X	X	X	Sinkiang	4	3	4	1	1	1
Chile	1	X	X	X	X	X	Tibet	4	2	3	1	1	1
Argentina	2	1	1	X	X	X	Nepal	1	X	X	X	X	X
Paraguay	1	X	X	X	X	X	Mongolia	3	2	1	X	X	X
Uruguay	1	1	X	X	X	X	Thailand	2	1	1	X	X	X
Iceland	2	2	1	X	X	X	Galapagos Island	1	X	X	X	X	X
Norway	2	2	2	1	X	X	Tanger Intl Zone	1	X	X	X	X	X
Sweden	2	2	2	2	X	X							
Eire	2	1	X	X	X	X							
Poland	3	2	1	1	X	X							
Luxembourg	1	X	X	X	X	X							
Yugoslavia	2	1	X	X	X	X							
Greece	2	1	X	X	X	X							

Minor Powers Land & Sea Zones

Name of Minor Power or Country	Regular Infantry	Special Forces Infantry	Armor (Tanks)	Fighter Plane	AA/AT Gun	Limited Production Factory	Name of Minor Power or Country	Regular Infantry	Special Forces Infantry	Armor (Tanks)	Fighter Plane	AA/AT Gun	Limited Production Factory
SPAIN (MP)							Belgium (MP)						
Spain (Capital)	4	2	1	1	1	1	Belgium (Capital)	3	3	2	2	1	1
Spanish Morocco	2	X	X	X	X	X	Belgium Congo	3	3	2	1	1	1
The Canary Islands	1	X	X	X	X	X	Point Noire	1	X	X	X	X	X
Sp. Prov. of Sahara	1	X	X	X	X	X	Ruanda	1	X	1	X	X	X
Balearic Islands	1	X	X	X	X	X	Burundi	1	X	1	X	X	X
Spanish Guinea	1	X	X	X	X	X							
Portugal (MP)													
Portugal (Capital)	2	2	1	1	1	1							
Azores Islands	1	X	X	X	X	X	Minor Power Sea Zones w/ Fleets	Transport Ships	Destroyers	Submarines	Cruisers		
Cape Verde Islands	1	X	X	X	X	X							
Portugese Guinea	1	X	X	X	X	X							
Angola	2	1	X	X	X	X							
Mozambique	2	1	X	X	X	X							
Denmark (MP)							Netherlands (MP)						
Denmark (Capital)	2	2	2	1	1	1	Suriname	1	X	1	1		
Greenland	1	1	1	X	X	X	Dutch Guinea	1	2	3	1		
Netherlands (MP)													
Netherlands (Capital)	2	2	2	1	1	1							
Suriname	1	1	1	X	X	X							
Dutch Guinea	1	1	X	X	X	X							

Appendix B - Technology Chart.

TECHNOLOGY CHART				
Die Roll	Subject Category	Level I Results \ Abilities	Level II Results \ Abilities	Level III Results \ Abilities
02	Fighter Aircraft	Attack on Die Roll "5" Defend on Die Roll "5"	Attack on Die Roll "5" Defend on Die Roll "6"	Attack on Die Roll "6" Defend on Die Roll "6"
03	Rocket Launchers	1 - Die Roll 1-6 Damage Firing range = 3 zones max.	1 - Die Roll 1-8 Damage Firing range = 4 zones max.	1 - Die Roll 1-10 Damage Firing range = 5 zones max.
04	Submarines	Attack on Die Roll "4" Defend on Die Roll "3"	Attack on Die Roll "4" Defend on Die Roll "4"	Attack on Die Roll "4" Defend on Die Roll "5"
05	Armor (Tanks)	Attack on Die Roll "3" Defend on Die Roll "3"	Attack on Die Roll "3" Defend on Die Roll "4"	Attack on Die Roll "4" Defend on Die Roll "4"
06	Aircraft Transportation Capacity	Transport Plane carries max 3 load factors.	Transport Plane carries max 4 load factors.	Transport Plane carries max 5 load factors.
07	Regular Infantry Units	Attack on Die Roll "2" Defend on Die Roll "2"	Attack on Die Roll "2" Defend on Die Roll "3"	Attack on Die Roll "3" Defend on Die Roll "3"
08	Land Transportation Capacity	Armored Personnel Carrier carries max 3 load factors.	Armored Personnel Carrier carries max 4 load factors.	Armored Personnel Carrier carries max 5 load factors.
09	Industrial Production	Purchase ALL Units at -1 IPU of Normal Cost except RADAR.	Purchase all Aircraft units at -2 IPU's off normal cost.	Purchase all Naval units at -2 IPU's off normal cost.
10	Destroyers	Attack on Die Roll "4" Defend on Die Roll "3"	Attack on Die Roll "4" Defend on Die Roll "4"	Attack on Die Roll "4" Defend on Die Roll "5"
11	Sea Transportation Capacity	Sea Transport ship carries max 3 load factors.	Sea Transport ship carries max 4 load factors.	Sea Transport ship carries max 5 load factors.
12	Aircraft Range Capability	All Aircraft units can move up to 2 extra zone per turn max.	All Aircraft units can move up to 3 extra zone per turn max.	All Aircraft units can move up to 4 extra zone per turn max.
13	Cruisers	Attack on Die Roll "6" Defend on Die Roll "5"	Attack on Die Roll "6" Defend on Die Roll "6"	Attack on Die Roll "6" Defend on Die Roll "7"
14	Aircraft Carriers	Takes 2 hits to destroy. Carries 3 aircraft load factors.	Takes 2 hits to destroy. Carries 4 aircraft load factors.	Takes 3 hits to destroy. Carries 5 aircraft load factors.
15	Battleships	Takes 2 hits to destroy. Attacks on "7" / Defends on "8"	Takes 2 hits to destroy. Attacks on "8" / Defends on "8"	Takes 3 hits to destroy. Attacks on "8" / Defends on "9"
16	Bombers	Unit gets 2 Standard attack rolls per round Attacks on "6" / Defends on "2"	Unit gets 3 Standard attack rolls per round Attacks on "7" / Defends on "2"	Unit can Deploy Atomic Bomb Unit!

Note: All Level III Technology Naval Ships can travel a Maximum of 3 Sea Zones per turn. All other Naval travel restrictions for these units still remain.

Appendix C - EBR Rules and Chart

Economic Bombing Raids (EBR's) are a different type of attack that a player may make to directly effect the production capability of an opposing player. A spy unit may aid in this type of attack as seen in the rules below if the spy unit has declared that it will make this type of mission and was not captured by special forces units. The procedures for this type of mission are as follows;

1. During the combat movement phase of the players' turn, the player moves a bomber unit to an enemy land zone containing an industrial factory unit. The player must elect at this time if all or none of the bomber units making an EBR attack in this zone will be escorted by fighters. If the player elects to have his/her bombers escorted, he/she must purchase an imaginary escort fighter for each bomber unit in this zone. Imaginary escort fighter units cost 1 IPU each.
2. During the combat phase of the players' turn where EBR attacks occur, the defending player must decide if any fighter units in that zone will attempt to shoot the bombers down. The fighter units must be in the zone where the bomber units are making the EBR attack at this time. If during the radar alert and fighter defense phase of the combat turn, a fighter unit was allowed to travel to this zone, it may participate in the defense of the EBR attack.
3. The defending player rolls one 8-sided die and consults the chart below for each fighter that has elected to defend against the EBR attack. Once the defending player has elected to roll a die for a fighter unit, he/she must make the die roll, even if all of the attackers' bomber units have been destroyed before the defending player has finished rolling for all of his/her fighter units.
4. For each surviving bomber unit that the attacking player still possesses, he/she may now make an EBR attack. To complete this, the attacking player rolls two 6-sided dice and adds the result together. This is the target industry to be effected. If the player has a Spy unit in the zone conducting an EBR assist mission, the attacking player can either keep the die roll indicated, add 1 to the die roll, or subtract 1 from the roll. This is now the target industry. Next the attacking player rolls one 6-sided die. This is the damage level in that target industry. A die roll of 6 means that the bomber unit has missed its target and hit inconsequential landscape. A defending players' counter marker is now placed on the appropriate section of the chart on the next page to indicated the damage inflicted to this industry.
5. If a player rolls an EBR attack on a particular industry that has already received damage from a previous EBR attack and the damage level is less than or equal to the current damage level in that industry, then the marker on the chart is not moved.
6. If a player rolls an EBR attack on a particular industry that has already received damage from a previous EBR attack and the damage level is greater than the current damage level in that industry, then the marker on the chart is moved to the new higher damage level.

DEFENDING FIGHTER DAMAGE CHART

DIE ROLL	Effect when Bomber unit is not escorted.	Effect when Bomber unit is escorted.
1	Attacking Bomber Unit Destroyed	Attacking Bomber Unit Destroyed
2	Attacking Bomber Unit Destroyed	Attacking Bomber Unit Destroyed
3	Attacking Bomber Unit Destroyed	No effect
4	Attacking Bomber Unit Destroyed	No effect
5	No effect	No effect
6	No effect	No effect
7	No effect	Defending Fighter Unit Destroyed.
8	Defending Fighter Unit Destroyed.	Defending Fighter Unit Destroyed.

Economic Bomb Raid Attack / Damage Chart

AREA DIE ROLL	RESOURCE	EFFECTED UNIT(S)	Damage Level Die Roll				
			Die Roll 1	Die Roll 2	Die Roll 3	Die Roll 4	Die Roll 5
02	Munitions	Attack Dice Rolls	+1 to all Att. Dice	+1 to all Att. Dice	+2 to all Att. Dice	+2 to all Att. Dice	+3 to all Att. Dice
03	Food	ALL Units	Maximum Production = 4 Units	Maximum Production = 3 Units	Maximum Production = 2 Units	Maximum Production = 1 Unit	No Production Allowed
04	Textiles	ALL Infantry	Maximum Production = 4 Units	Maximum Production = 3 Units	Maximum Production = 2 Units	Maximum Production = 1 Unit	No Production Allowed
05	Ball Bearings	ALL Air Units Armor and APC's	Maximum Production = 4 Units	Maximum Production = 3 Units	Maximum Production = 2 Units	Maximum Production = 1 Unit	No Production Allowed
06	Building Materials	ALL Land Units and Factories	Maximum Production = 4 Units	Maximum Production = 3 Units	Maximum Production = 2 Units	Maximum Production = 1 Unit	No Production Allowed
07	Shipyards	ALL Sea Units	Maximum Production = 4 Units	Maximum Production = 3 Units	Maximum Production = 2 Units	Maximum Production = 1 Unit	No Production Allowed
08	Rubber	ALL Air Units	Maximum Production = 4 Units	Maximum Production = 3 Units	Maximum Production = 2 Units	Maximum Production = 1 Unit	No Production Allowed
09	Electronics	Technology Dice and Radar	1 Tech Roll No Radar	No Tech No Radar	No Tech No Radar	No Tech No Radar	No Tech No Radar
10	Steel	ALL Units Except Infantry	Maximum Production = 4 Units	Maximum Production = 3 Units	Maximum Production = 2 Units	Maximum Production = 1 Unit	No Production Allowed
11	Oil / Gas	ALL Units	Maximum Production = 4 Units	Maximum Production = 3 Units	Maximum Production = 2 Units	Maximum Production = 1 Unit	No Production Allowed
12	Command	Defense Dice Rolls	+1 to all Def. Dice	+1 to all Def. Dice	+2 to all Def. Dice	+2 to all Def. Dice	+3 to all Def. Dice

Appendix D - Sea Search Rules and Chart.



Whenever a battle is to take place in a sea zone, The units in that zone must be searched for and found before the battle can take place. The sheer vastness of the sea zones on the map board could make it quite easy for 2 fleets to sail right by each other and never see the other. Here are the procedures on how 1 set of units finds another set in a sea zone.

Finding an opponent in a sea zone is based on search dice. The more search dice a player can accumulate, the better the odds of finding your opponent. The maximum number of search dice allowed in any sea zone battle is 10 dice.

1. Consult the chart below and count up the number of search dice the attacker gets to roll based on the number of units the attacking player has in the sea zone. Count each unit or group of units separately. The chart indicates the maximum number of search dice the attacking player can earn per group type.
2. After determining the total number of search dice a player accumulated based on the real units in the sea zone, the player may now purchase imaginary Sea Search Plane Units at a cost of 1 IPU each until the player has reach a total of 10 search dice. This purchase is optional, but must be made before any search dice are rolled.
3. The player then rolls 1 6-sided die for each search die accumulated in steps 1 and 2 above. If the the result on ANY 1 of the dice is a 1 or a 2, all the opponents units in the sea zone have been found, and the player continues to the next step in the combat phase of their turn.
4. If the attacking player does not successfully find the defending players units, the defending player at this time has 3 options;
 - a. The defending player may retreat his/her units to a different sea zone where no combat has been declared. If no such sea zone exists, this option is not allowed.
 - B. If the defending player possesses any Battleship units in the sea zone, the defending player may force the attacking player to retreat his/her attacking units.
 - C. The defending player may roll 1 search die to find the attacking players units. If the die roll is successful, the defending player may pick up to any 3 of his/her units and fire a free round of defense rolls against the attacking units. The attacking player then removes his/her casualties. At this point, the defenders units are considered to be found by the attackers units, and the player continues to the next step in the combat phase of his/her turn. If the defenders die roll is not successful, then the players repeat steps 3 and 4 in this section until a resolution is made.

Type(s) of Units Conducting Search	# of that Unit(s) Searching / # of search Dice acquired.								
	01	02	03	04	05	06	07	08	09
Transport Ship / Submarine / Destroyer	01	01	01	01	01	02	02	02	02
Cruiser / Aircraft Carrier / Battleship	01	01	02	02	03	03	04	04	05
Fighter	01	01	02	02	03	03	04	04	05
Transport Plane	01	02	03	04	05	06	07	08	09
Bomber	01	01	02	02	03	03	04	04	05
Sea Search Plane (Cost 1 IPU each)	01	02	03	04	05	06	07	08	09

Appendix E - Aircraft Carrier readiness rules and chart.

Whenever a battle takes place in a sea zone, and the defending player has an aircraft carrier unit in the sea zone with aircraft units aboard, the defending player determines the readiness status for each aircraft carrier in the zone.

To determine the readiness status of an aircraft carrier, the player must complete the following.

1. If multiple aircraft carrier units are in the sea zone, the defending player must separate out each aircraft carrier unit and designate which aircraft are aboard which aircraft carrier before any die rolls are made.
2. A separate die roll must be made for each aircraft carrier unit. A 6-sided die is used to determine the status of the aircraft carrier. The result of the die roll effects all aircraft units on board the aircraft carrier unit. If any aircraft carrier makes its radar activation roll (1 or 2 on a 6-sided die), then all the aircraft carriers in the sea zone get to add +1 to the die roll below to a maximum of 6.
3. Aircraft aboard the aircraft carrier readiness is measured in combat points. It takes 1 combat point to either participate in a combat round in the sea zone, or retreat 1 zone to a different land or sea zone. It does not cost any combat points to land the aircraft. If the aircraft cannot land in a friendly land or sea zone, the unit is considered lost. Units lost in this manner are not considered as taking a casualty. If an aircraft has run out of combat points at the end of a combat round, it must land or be considered lost. All aircraft must spend 1 combat point per combat round until it lands. If combat ends in the original sea zone before any aircraft have expended the remainder of their combat points, they may use these points only to retreat from the original sea zone. Aircraft may not pursue and attack any enemy units. Transport planes that are carrying infantry units may not participate in the combat in the sea zone and cannot be taken as a casualty in the battle.

Consult the chart below for the status and result of each die roll.

AIRCRAFT CARRIER READINESS CHART

DIE ROLL	CARRIER STATUS	EFFECT OF READINESS ON ALL AIRCRAFT
01	STANDING DOWN	All aircraft are below decks and unfueled.
02	CONDITION GREEN	All aircraft receive 1 combat point
03	YELLOW ALERT	All aircraft receive 2 combat points
04	RED ALERT	All aircraft receive 3 combat points
05	FULL ALERT	All aircraft receive 4 combat points
06	GENERAL QUARTERS	All aircraft receive 5 combat points, but maximum retreat range is still limited to 4 zones.

Appendix F - Diplomacy Rules and Chart.

During the combat phase of a players' turn, the player may make 1 attempt to get a country to join in its cause to rule the world. There are 4 conditions that must be met before this attempt can be made.

1. The player must move into position a total of 8 units from any source where they can attack this country. (Either by land, air, amphibious assault, or shore bombardment). Units that cannot be counted in this 8 unit rule are spies, Rocket Launchers, APC's, Transport planes, Transport ships, Submarines, Destroyers, Aircraft Carriers, and Atomic Bombs. This movement must be completed during the combat movement phase of the players' turn.
2. No other Player can ever have previously attacked this territory whether the attack was successful or not.
3. No other player can ever have made an attempt at diplomacy to take over this country where the result was insulting to the country in question.
4. Diplomacy attempts can only be made against neutral countries, or Minor power nations. Diplomacy attempts cannot be made against a zone owned by a major faction player.

Once the player has met the above 4 conditions, the player must roll 1 10-sided die and consult the chart below.

DIE ROLL	RESULT	ACTION TAKEN
01	Full Join	Country joins players faction. All of the countries units PLUS its reserve units become property of the player.
02	Adv. Join	Country joins players faction. All of the countries regular units become property of the player. Reserve units are called up, but must remain in the host country.
03	Reg. Join	Country joins players faction. All of the countries regular units become property of the player. No reserves.
04-07	No Action	Country is not interested. Player must retreat or attack.
08	Mild Insult	Country is insulted. Player must either pay 2 IPU's to retreat or attack.
09	Major Insult	Country is insulted. Player must either pay 5 IPU's to retreat or attack. Neutral country calls up reserves.
10	Extreme Insult	Country is insulted. The neutral country calls up its reserves and attacks the player. After the neutral country has completed its attacks, the player may then decide to either retreat or attack.

Appendix G - Player Reference Card.

UNIT NAME	STANDARD IPU COST	STANDARD ATTACK	STANDARD DEFENSE	STANDARD MOVEMENT
Regular Infantry	3	1	2	1
Special Forces Infantry	4	2	2	1
Armored Personnel Carrier (APC)	3	N/A	1	2
Armor (Tank)	5	3	2	2
Fighter	10	4	5	4
Transport Plane	8	N/A	1	4
Bomber	12	5	1	6
Transport Ship	6	N/A	1	2
Submarine	8	3	3	2
Destroyer	8	3	3	2
Cruiser	13	5	5	2
Aircraft Carrier	16	1	3	2
Battleship	20	7	7	2
AA / AA Gun	5	N/A	1	1
Coastal Gun	5 + 5 or 14	N/A	4	1
Radar	1	N/A	SPECIAL	N/A
Spy	2	SPECIAL	SPECIAL	1
Atomic Bomb	12 (+6)	SPECIAL	N/A	SPECIAL
Industrial Factory	10 (+5)	N/A	N/A	SPECIAL

- NOTES: 1. Please see each countries reference page for special purchases, attacks, and defenses.
 2. Atomic Bomb IPU cost goes up by 6 IPU's for each unit a player purchases.
 3. Spy, Radar, and Atomic Bomb purchases are limited to 1 unit each per turn.

Appendix H - Battle Reference card.

DIE ROLL	ATTACKER	DEFENDER
0	APC's Transport Planes Transport Ships	CASUALTY BOX
1	Regular Infantry Aircraft Carrier	APC's Transport Planes Transport Ships AA / AA Gun Bomber
2	Special Forces Infantry	Regular Infantry Special Forces Infantry Armor (Tanks)
3	Armor (Tanks) Submarines Destroyers	Submarines Destroyers Aircraft Carriers
4	Fighters	Coastal Gun
5	Bombers Cruisers	Fighters Cruisers
6		
7	Battleships	Battleships

NOTE: This chart only indicates standard dice rolls. Technology may effect some units attack or defense dice rolls.

Appendix I - Alternate rules for Empire building version.

Setup:

There are up to 9 players for this version of the game. A player can play the neutral players pieces as a standard player for this version.

Each player draws a tile randomly out of a hat to determine which pieces and rules they will be playing under. All country abilities from the original version of the game are the same with 2 exceptions.

- 1) There are no designated teams or alliances. Players cannot have pieces in the same zone working together.
- 2) All zones not claimed at the start of the game are considered neutral until captured by a player.

Each player designates in turn the location of their capital by placing their capital factory in the zone. (Any zone in the entire world regardless of color). This zone must be a named zone containing an IPU number designation.

This zone is now worth 10 IPU's. After all the players have chosen a capital all other zones with any IPU designation are now worth 2 IPU's for the rest of the game.

Each player starts with 200 IPU's to purchase units and place them in their capital zone. Play then starts and goes in order as if there are 8 players with the neutral player going last. If a player purchases sea units, they may only be placed in a sea zone adjacent to their capital zone. Sea zone availability is on a first come-first served basis by turn order for who may place the units in the zone.

There is no Capital relocation for this version of the game. If a player's capital zone is captured, they are eliminated from the game. The capital zone that was captured is still worth 10 IPU's, but all the players remaining pieces are removed from the board, and all controlled zones for that player go back to being neutral territories.

The game is over when either only one player remains, or an agreed time or turn round has been completed. The player with the largest economy is the winner in the case that there are more than 1 player left at the end of the game.

Diplomacy for neutral countries is considered differently. The rules for a diplomacy role are the same, but the standing army in the zone is determined by using the chart below.

Number of each type of unit in a neutral country

Die Roll 1 - 20 Sided Die	Regular Infantry	Special Forces Infantry	Reserve Infantry	Armor (Tanks)	Fighter Plane	AA/AT Gun
1-2	1	0		0	0	
3-4	2	1		1	0	
5-6	3	1		1	0	
7-8	4	2		2	1	
9-10	5	2		2	1	
11-12	6	3		3	1	
13-14	7	3		3	2	
15-16	8	4		4	2	
17-18	9	4	1	4	2	
19-20	10	5	2	5	3	1

5 World War II - The Complete Game **5**

FIVE

Issued on August 31, 1939

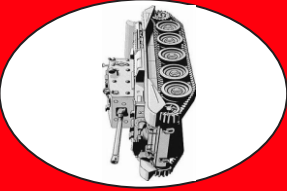

C 070904011102

5 Industrial Production Unit **5**

5 World War II - The Complete Game **5**

FIVE

Issued on August 31, 1939

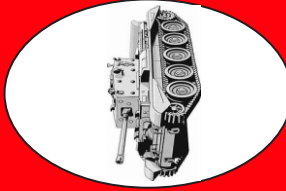

C 070904011102

5 Industrial Production Unit **5**

20 World War II - The Complete Game **20**

TWENTY

Issued on August 31, 1939



A 031094060856

20 Industrial Production Unit **20**

1 World War II - The Complete Game **1**

ONE

Issued on August 31, 1939



D 092761120965

1 Industrial Production Unit **1**

1 World War II - The Complete Game **1**

ONE

Issued on August 31, 1939



D 092761120965

1 Industrial Production Unit **1**

10 World War II - The Complete Game **10**

TEN

Issued on August 31, 1939



B 032159022670

10 Industrial Production Unit **10**

Appendix K - Recommended number of pieces to play the game

Regular Infantry units	50 per player (55 for United Kingdom)
Special Forces Infantry Units	40 per player (45 for United Kingdom)
Reserve Infantry Unit markers	9 total
Armored Personnel Carrier (APC)	25 per player
Armor (Tank)	25 per player
Fighter Plane	25 per player (30 for Japan and USA)
Transport Plane	16 per player
Bomber Plane	12 per player (16 for UK and USA)
Transport Ship	16 per player
Destroyer Ship	20 per player
Submarine	18 per player (25 for Germany)
Cruiser Ship	12 per player
BattleShip	8 per player (12 for Japan and USA)
Aircraft Carrier	8 per player (12 for Japan and USA)
Sea Search Plane	10 total
AA/AT Gun	80 total
Coastal Gun	5 per player
Rocket Launcher	25 total
Atomic Bomb	10 total
Spy Unit	35 total
Limited Production factory	50 total
Unlimited Production factory	5 per player
Capital Production factory	1 per player
1" Player markers	60 per player
1" white poker chips	500 total
1" red poker chips	200 total
1" blue poker chips	100 total
1" yellow poker chips	100 total
6 each of 4, 6, 8, 10, 12, and 20 sided dice.	
1-IPU Money markers	50 total
5-IPU Money Markers	50 total
10-IPU Money Markers	25 total
20-IPU Money Markers	25 total
Grand Total of all pieces	3913

Acknowledgment and thanks.

I would like to specifically name the following people who have helped me over the years develop and play test this game.

Editing:

Peter Thoes “The Mafia”

Play Testing:

Bruce (Brad) Bradford “Patton”
Keith Crews “The Admiral”
Michael Finley “Göring”
James Franklin “Adolf”
Anthony Hojnacki “The Diplomat”
Aaron Ingle “Ike”
Peter Kaufman “Stalin”
Rory Langren “The Major”
Art Stanphill “The Marshall”
Peter Thoes “The Mafia”

Piece Design:

Sandra Fontaine “The Queen”
Peter Thoes “The Mafia”

Painting:

Sandra Fontaine “The Queen”
Bently Fontaine “Boo”

Sincerely;

Charles E. Fontaine Jr. “The Master”